

ASSEMBLING
AND USING
YOUR

Heathkit

VISUAL-AURAL
SIGNAL TRACER
MODEL T-3

595-43

HEATH COMPANY

BENTON HARBOR,
MICHIGAN

PRICE \$1.00

THE WORLD'S *Finest* TEST EQUIPMENT IN KIT FORM

STANDARD COLOR CODE — RESISTORS AND CAPACITORS

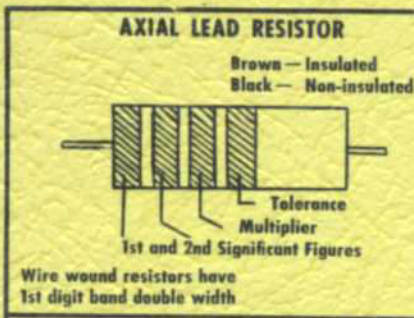

INSULATED UNINSULATED Color	FIRST RING BODY COLOR First Figure	SECOND RING END COLOR Second Figure	THIRD RING DOT COLOR Multiplier
BLACK	0	0	None
BROWN	1	1	0
RED	2	2	00
ORANGE	3	3	,000
YELLOW	4	4	0,000
GREEN	5	5	00,000
BLUE	6	6	000,000
VIOLET	7	7	0,000,000
GRAY	8	8	00,000,000
WHITE	9	9	000,000,000

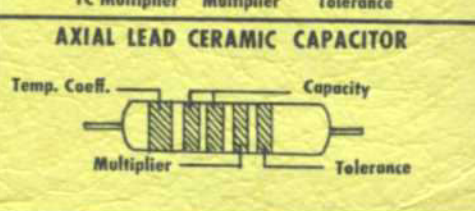
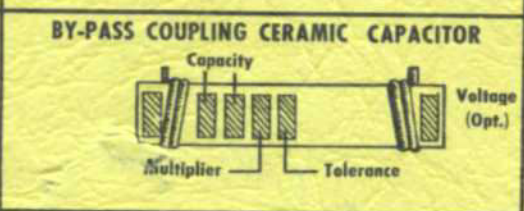
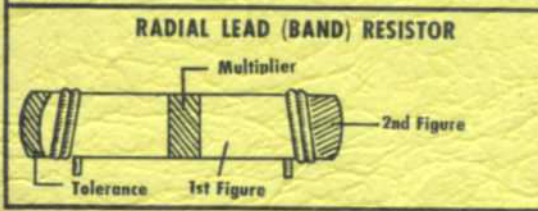
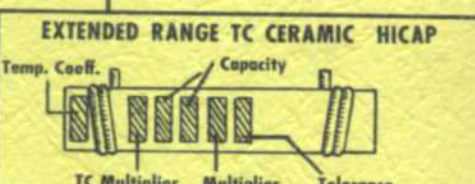
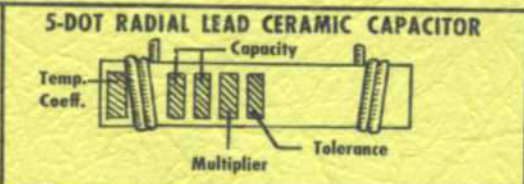
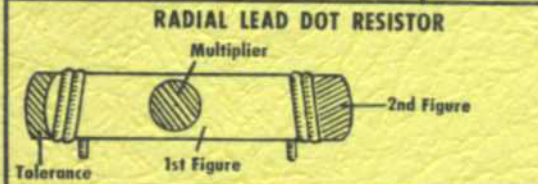
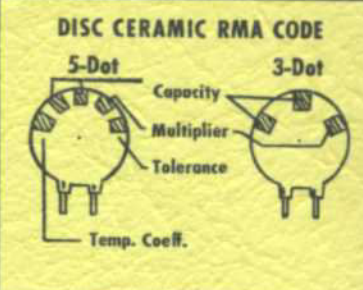

The standard color code provides all necessary information required to properly identify color coded resistors and capacitors. Refer to the color code for numerical values and the zeroes or multipliers assigned to the colors used. A fourth color band on resistors determines tolerance rating as follows: Gold = 5%, silver = 10%. Absence of the fourth band indicates a 20% tolerance rating.

The physical size of carbon resistors is determined by their wattage rating. Carbon resistors most commonly used in Heathkits are 1/2 watt. Higher wattage rated resistors when specified are progressively larger in physical size. Small wire wound resistors 1/2 watt, 1 or 2 watt may be color coded but the first band will be double width.

MOLDED MICA TYPE CAPACITORS

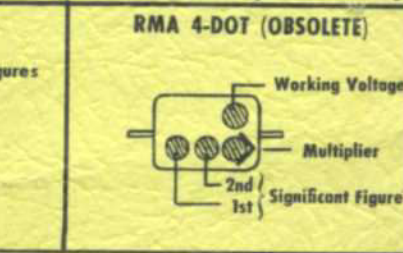
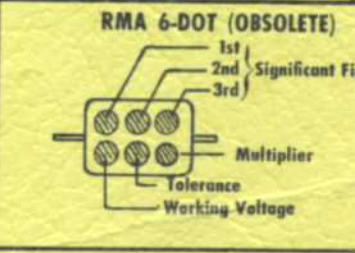
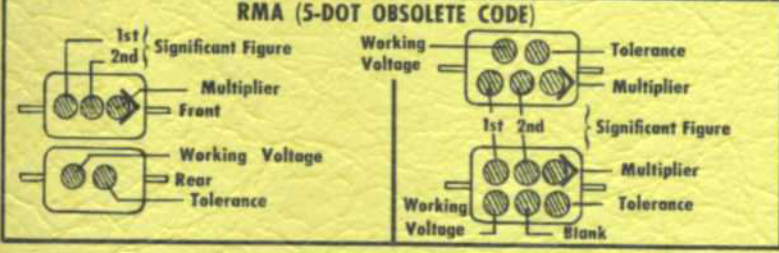
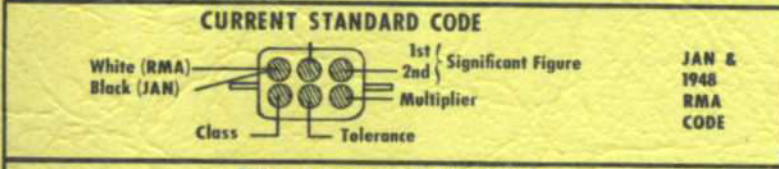

MOLDED PAPER TYPE CAPACITORS

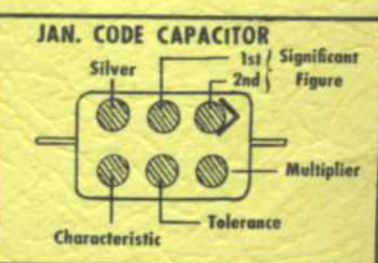
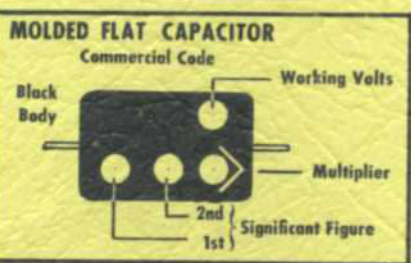
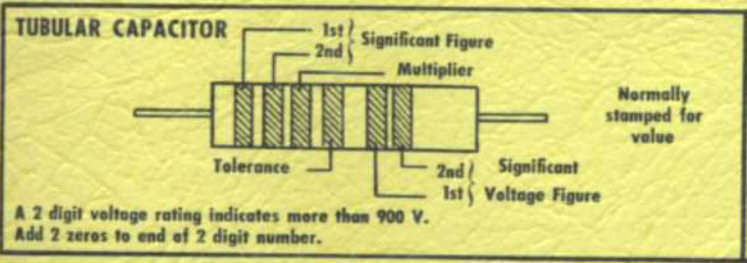

The tolerance rating of capacitors is determined by the color code. For example: red = 2%, green = 5%, etc. The voltage rating of capacitors is obtained by multiplying the color value by 100. For example: orange = 3 × 100 or 300 volts. Blue = 6 × 100 or 600 volts.

In the design of Heathkits, the temperature coefficient of ceramic or mica capacitors is not generally a critical factor and therefore Heathkit manuals avoid reference to temperature coefficient specifications.

HEATHKIT VISUAL-AURAL SIGNAL TRACER MODEL T-3



FEATURES AND APPLICATIONS

- High gain RF channel for direct observation of actual transmitted signal. Can be used for AM, FM and TV circuit investigation.
- Low gain channel for audio circuit exploration.
- Visual signal indicator.
- Convenient wattmeter circuit.
- Noise locator circuit.
- Utility amplifier for checking record changers, tuners, etc.
- Useful for checking microphones, musical instrument pickups and speakers.
- Substitution test speaker and output transformer.
- Oscilloscope preamplifier.
- VTVM panel terminals.
- Output meter.

TUBE COMPLEMENT

- 12C8 amplifier and wattmeter rectifier.
- 12SH7 high gain pentode amplifier.
- 12A6 beam power output.
- 1629 electron beam visual indicator.
- 6X5 full-wave rectifier.

PROBES AND TEST LEADS

- Shielded RF probe and lead.
- Audio probe and lead.
- Two flexible panel test leads with alligator clips.

SPECIFICATIONS

- Cabinet size 9½" wide 6½" high 5" deep.
- Shipping weight 8 pounds.
- Power requirements 110 to 120 volts AC at 50-60 cycles.

ASSEMBLY AND OPERATION OF THE MODEL T-3 VISUAL-AURAL SIGNAL TRACER

The Model T-3 Signal Tracer is not difficult to construct but it is extremely important that particular emphasis be placed on the desirability of following parts placement and wiring dress as shown in the manual. This is important in order that the operation of the Signal Tracer be hum free and that a motor boating condition is not induced. The wiring dress and parts layout as shown in the manual has been proven thoroughly satisfactory through the construction of a series of laboratory models.

Large pictorial work sheets are furnished for the convenience of the kit builder and it is suggested that these sheets be fastened to the wall over the work space available. The work sheets are reproductions of pictorials that appear in the manual. The manual should be retained for future technical reference.

Many components are supplied by the manufacturer with leads that are longer than the particular application requires. Of course, all excess lead lengths should be removed so as to permit neat and direct installation of the component involved. Following this procedure will very definitely result in superior operation of the instrument and will afford the kit builder a definite sense of satisfaction and pride in having constructed a neat, professional appearing instrument.

Occasionally, transformer leads of solid copper will have a baked brown enamel coating. After these leads have been trimmed to the proper length, a sufficient area of the lead end should be scraped with a knife to remove the enamel coating. Otherwise it will be impossible to obtain an electrically good soldered connection. Whenever necessary, use spaghetti or insulated sleeving over bare wires on condensers or resistors to prevent the leads from accidentally touching adjacent terminals or wires.

Unless otherwise indicated in the construction procedure, all resistors are one half watt. All indicated wire connections refer to the hookup wire supplied with the kit. When the use of bare wire or shielded wire is required, it will be so specified in the manual.

Use lock washers under all 6-32 and 8-32 nuts. Lock washers should be placed between controls and the panel. When solder lugs are mounted under 6-32 nuts, the use of lock washers is unnecessary. When soldering, use enough heat at the point of connection to allow a smooth, even flow of solder. Avoid excessive use of solder to prevent a possible solder flux flooding condition. Be sure to use solder that is plainly marked, "Rosin core solder."

Resistors and controls generally have a tolerance rating of + 20% unless otherwise stated. Therefore, a 10,000 ohm resistor may test anywhere from 8,000 to 12,000 ohms. The tolerance on condensers is even greater. Limits of -50% and +100% are common for paper tubular types. This Heathkit is designed to accommodate such variations.

Small changes in parts may be made by the Heath Company. All parts supplied will work just as well as the part for which it was substituted. By reading the color code on resistors, for instance, it will be readily understood that a value of 3.9 megohms is a substitute for the specified 3.3 megohms or a resistor coded 8,200 ohms is a substitute for the specified 10,000 ohms provided the specified values are not supplied. Such changes will only be made if the specified parts are unobtainable at the time and are only made to insure a minimum delay in filling your order.

MECHANICAL ASSEMBLY

Carefully study pictorial 1 and pictorial 2 for information regarding the installation of components on the chassis. The assembly procedure first requires the mounting of chassis components then the panel is fastened to the chassis and the remaining panel components are mounted.

- () Install the six $3/8$ " rubber grommets in the manner shown in pictorial 2.
- () Install octal socket F with keyway towards outer chassis edge.
- () Install octal socket G with keyway pointed diagonally toward chassis corner.
- () Install octal socket J with keyway pointed diagonally.
- () Install octal socket K with keyway pointed towards center of chassis.
- () Install mounting wafer for condenser H, using 6-32 screws and nuts. Mount one lug terminal R on same condenser mounting 6-32 screw. Refer to pictorial 2.
- () Mount spring base clip S, using a 6-32 screw. On top of chassis, mount 2 lug terminal U on same 6-32 screw.
- () Install 1 lug terminal strip P using a 6-32 screw.

TOP CHASSIS VIEW

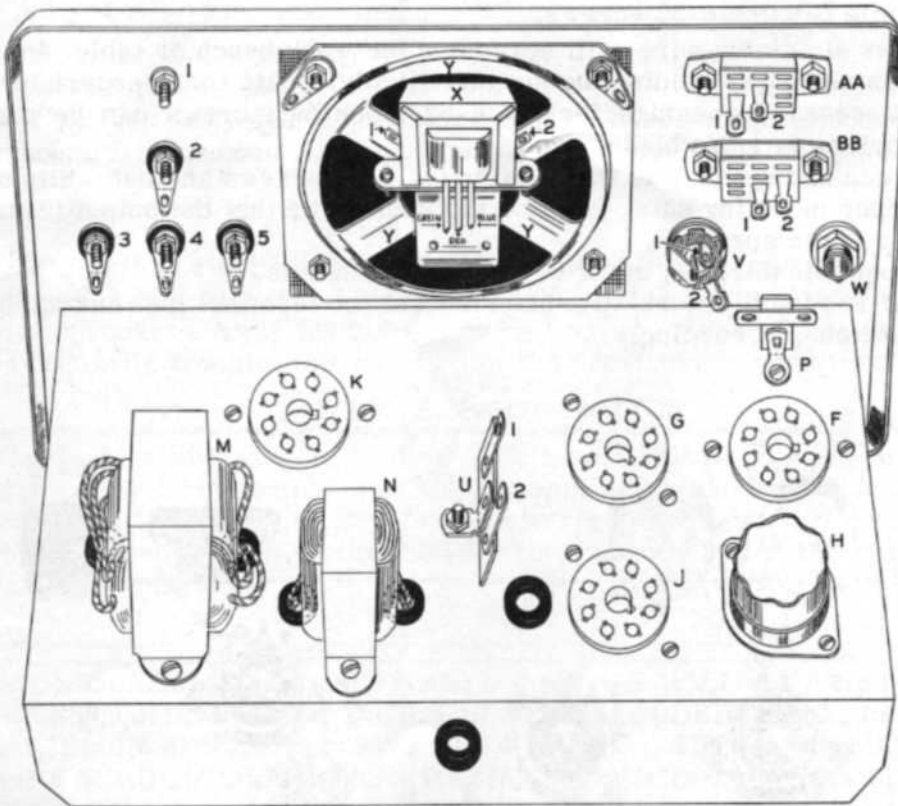

PICTORIAL 1

- () Mount wattmeter transformer in so that red transformer leads dress through rubber grommet closest to 2 lug terminal T. Refer to pictorial 3. On the same two transformer 6-32 mounting screws, install the 2 lug terminal T and 3 lug terminal Q on the bottom of the chassis as shown in pictorial 2.
- () Mount the power transformer with 8/32 screws. Place leads in the following manner: The two black leads, the two red leads and the red-yellow lead are dressed through the rubber grommet nearest the chassis edge. All other transformer leads are dressed through the remaining rubber grommet.
- () Fasten the chassis to the panel using controls A and D. Place a control lockwasher between the control and chassis. Slip the threaded control bushing through the corresponding opening in the panel and install a flat nickel washer between the panel and control nut. This procedure is followed in mounting controls A and D.

- () Mount panel switch B using a control lockwasher between control and panel and a flat nickel washer between panel and control nut. Switch placement should be made so that the two single terminals on the inner radius of the terminal grouping will be in a vertical plane and the two groups of three terminals on the outer radius will be to the right side and the left side of the vertical plane.

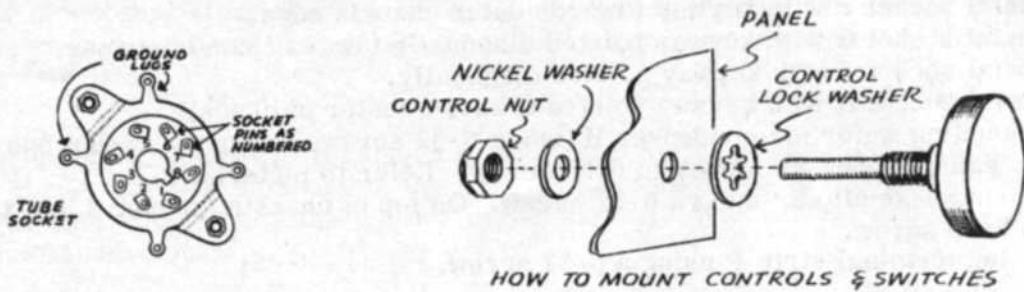

- () Mount receptacle C using 6-32 screws.
- () Lay the speaker aluminum wire grill screen on the work bench or table. Place the speaker over the screen and while holding the speaker firmly, locate the appropriate openings in the screen. The necessary openings for the 6-32 mounting screws can be made by using a small screw driver or knife blade.
- () Mount the screen and speaker to the panel using 6-32 screws and nuts. Slip solder lugs under the two upper mounting nuts. Position the speaker so that the output transformer can be mounted on top of the speaker.
- () Mount the output transformer, using 6-32 screws and nuts.
- () Study pictorial 1 and note the relative placement of the terminal lugs on switches AA and BB. Mount these switches accordingly.

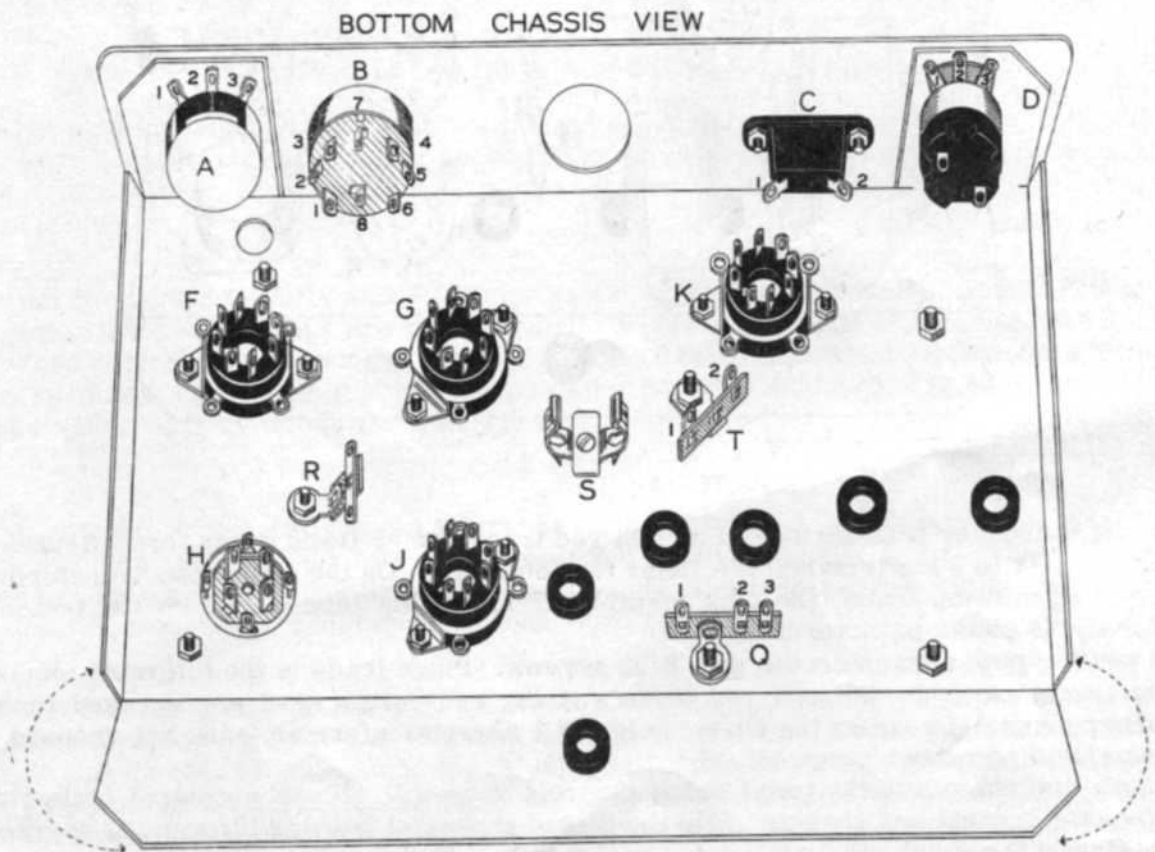

PICTORIAL 2

- () Mount phone jack V using control lockwasher between phone jack and panel and a flat nickel washer under the panel mounting nut.
- () Mount panel connector W and use a control lockwasher under the mounting nut. Remove any fiber bushings or rubber washers that may be supplied with this connector.
- () Mount the five binding post assemblies as shown using shoulder and flat fiber washers on all binding posts. On the top or No. 1 binding post, the rear flat fiber washer is omitted and the shoulder washer is supplied only to insure proper centering. This binding post should be grounded to the panel.
- () Mount filter condenser H in the condenser mounting wafer. Be sure to properly orient the lug coding at the base of the condenser terminals before fastening the condenser in place. Check pictorial 2 and 3 for this information. The condenser should be mounted by twisting the mounting prongs while the condenser is held firmly against the mounting wafer.

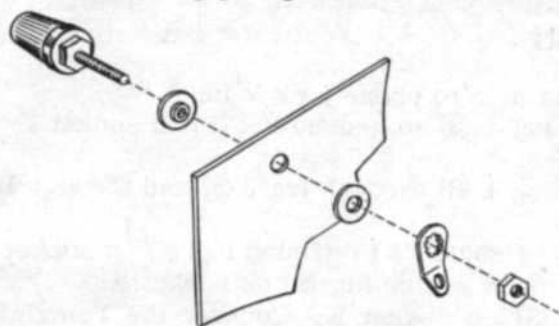

BINDING POST ASSEMBLY

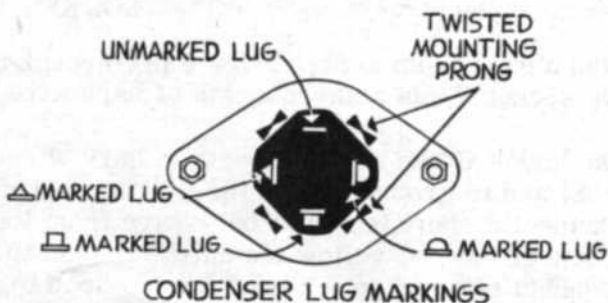

CONDENSER LUG MARKINGS

Before proceeding with the actual wiring of the instrument, it would be well to carefully recheck all mechanical mounting of components. Make sure that lugs on controls and switches are properly located and that socket keyway installations are correct. Careful checking at this point of construction can eliminate troublesome correction after instrument construction has been completed.

Note that the subsequent wiring steps all follow a definite pattern. For the matter of convenience, all components already assembled to the chassis and panel have been assigned alphabetical classifications. The lugs or terminals of these components are assigned numerical designations. It would be helpful for the kit builder to similarly mark the components already mounted on the chassis and panel.

NOTE: ALL GUARANTEES ARE VOIDED AND WE WILL NOT REPAIR OR SERVICE INSTRUMENTS IN WHICH ACID CORE SOLDER OR PASTE FLUXES ARE USED. WHEN IN DOUBT ABOUT SOLDER, IT IS RECOMMENDED THAT A NEW ROLL PLAINLY MARKED "ROSIN CORE RADIO SOLDER" BE PURCHASED.

STEP BY STEP WIRING

(S) means solder. (NS) means do not solder yet.

FILAMENT WIRING

- () Twist together two 24" lengths of hookup wire to be used for filament and AC wiring in this instrument.
- () Cut off a 5" length of twisted wire and connect one wire to socket J lug 2 (NS) and the other wire to lug 7 (NS).
- () Connect the remaining ends of the twisted wire to socket F lug 2 (NS) and lug 7 (NS).
- () Cut another 5" length of twisted wire and connect to socket F, one wire to lug 2 (S) and the other wire to lug 7 (S).
- () Connect the remaining ends of the twisted wire to socket G lug 2 (S) and lug 7 (S).

- () Twist together the green and green-red leads of the power transformer. Connect the green lead to socket J lug 7 (NS). Connect the green-red lead to socket J lug 2 (NS). Be sure to follow this color coding carefully.
 - () Connect a 6" length of wire from socket J lug 2 (NS) to socket K lug 2 (S).
 - () Connect green-yellow power transformer lead to socket K lug 7 (NS).
 - () Connect a wire from socket K lug 7 (S) to ground lug on socket K (NS).
- This completes filament wiring with the exception of the round octal tube socket. This socket will be installed in a later step which will require the soldering of lug 2 and 7 in socket J. Re-check the filament wiring already installed and push the #2 and #7 lugs of the tube sockets down to a horizontal position but do not permit grounding to the ground solder lugs or chassis. The filament wiring itself should then be pushed well against the chassis to afford maximum isolation from adjacent terminals and wiring.

SOCKET WIRING

- () Run a wire from socket F lug 8 (S) through chassis hole to phone jack V lug 1 (NS).
- () On socket F run a short length of bare wire from lug 1 (S) to ground lug (S) on socket F.
- () On socket G run a short length of bare wire from lug 1 (S) through lug 3 (S) and through lug 5 (S) and to ground solder lug (NS) on socket G.
- () Connect a short length of bare wire from lug 1 (S) of socket J to ground lug (S) on socket J.
- () Connect the red-yellow transformer lead to the ground solder lug (S) on socket K.
- () Connect one red power transformer lead to lug 3 (S) on socket K. Connect the remaining red power transformer lead to lug 5 (S) on socket K.
- () Twist together the black power transformer wires and connect one wire to Q1 (NS) and the other wire to Q2 (NS).

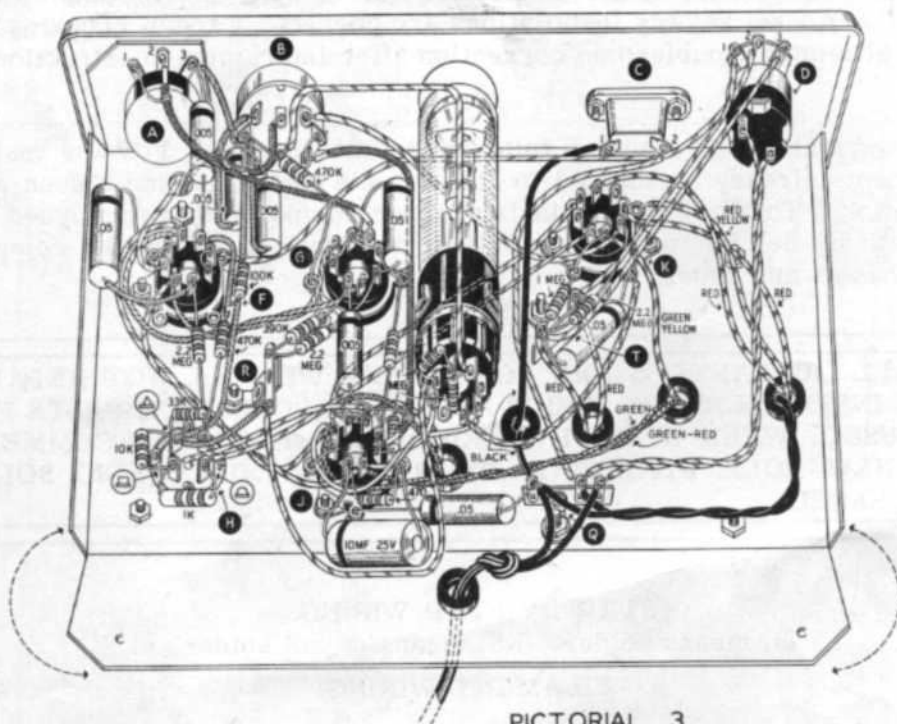

PICTORIAL 3

- () Install a .05 condenser from Q1 (NS) to ground solder lug (S) of socket J. Push the condenser down along the chassis bend.
- () Connect a 6½" length of wire from K8 (S) to lug ◐ of condenser H (NS).
- () Install a 1000 ohm (brown, black, red) two watt resistor from condenser lug ◐ (S) to condenser lug ◑ (NS) of condenser H.
- () Install a 10K resistor (brown, black, orange) from condenser lug ◒ (NS) and to condenser lug ◓ (NS) of condenser H.

PREPARATION OF SHIELDED WIRE

Several wiring steps will require the preparation of shielded wire and this can be accomplished in the following manner: Cut a suitable length of shielded wire for the particular connection involved; then carefully remove a 3/4" length of the outer shield from each end of the wire. Diagonal cutters can be used very nicely for this purpose. Next expose a 1/4" portion of the inner wire by carefully removing the insulation. Take a 3" length of bare wire and wrap 3 or 4 turns on the shielded wire near the end. The bare wire turns should then be soldered to the shielded braid. The other end of the length of shielded wire should be prepared in a similar manner. Note that in some instances the use of a bare wire wrap at each end is not required. Refer to the pictorial sketch for further information regarding this procedure.

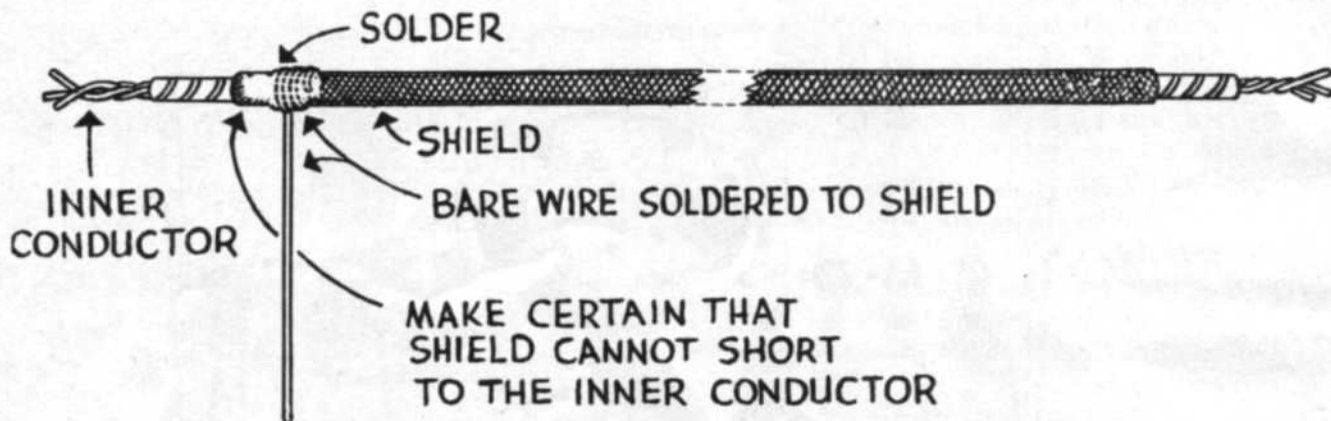

- () Prepare a 5" length of shielded wire with a bare wire wrap at one end only.
- () Connect the bare wire wrapped end of the shielded wire to J6 (S). Connect the bare wire wrap to ground solder lug (S) of socket J.
- () Connect the free end of shielded wire through B6 (S) and to B5 (S).
- () Prepare a 3" length of shielded wire with a bare wire wrap at each end.
- () Connect one end of the shielded wire to A2 (S). Connect bare wire ground wrap at A1 (S).
- () Connect the other end of shielded wire to G4 (S). Connect the bare wire ground wrap to ground solder lug (S) on socket G.
- () Prepare a 5" length of shielded wire and install bare wire wrap 6" long on one end only.
- () Install free end of shielded wire down through top of chassis opening and connect to B7 (S). Check pictorial 3 for proper wire dress. Spot solder the shield portion of the wire to the shielded wire connected between control A and socket G as shown in pictorial 3. Avoid excessive use of heat to prevent possible damage to internal wire insulation.
- () Connect the other end of the shielded wire to V2 (S)
- () Connect the 6" bare wire wrap through V1(NS) and through BB1 (S) and to solder lug (NS) under speaker mounting nut.
- () Prepare a 2 1/2" length of shielded wire with a bare wire wrap on one end only. Solder the grid cap to the free end of the shielded wire being careful that the shielded portion does not touch the grid cap.
- () Connect the other end of the shielded wire to one lug terminal P (NS).
- () Connect the shielded wire bare wire wrap to V1 (NS).
- () Connect a short length of bare wire from BB2 (S) and to one lug terminal P (S).
- () Install a 2.2 Meg resistor (red, red, green) from one lug terminal P (NS) to V1 (S).
- () Cut the lead of a .005 condenser so that it can be snugly soldered to inner terminal of panel connector W. Check the lead for proper length and then install a short length of spaghetti over the lead to prevent possible shorting. Hold the condenser and lead in place and spot solder to the center terminal of connector W.
- () Connect the remaining end of the .005 condenser to one lug terminal P (S).

FINAL AMPLIFIER WIRING

- () Install a 390K resistor (orange, white, yellow) from G3 (NS) to one lug terminal R (NS).
- () Install a .05 condenser from G6 (NS) to ground solder lug on socket G (S).
- () Connect a 2.2 Meg resistor (red, red, green) from G6 (S) to one lug terminal R (S).
- () Connect a .005 condenser from G8 (S) to J5 (NS)
- () Install a 1 Meg resistor (brown, black, green) from J5 (S) to socket G ground lug (S).

WATTMETER WIRING

- () Connect the black leads of transformer N to Q1 (NS) and to C1 (S).
- () Connect the red leads of transformer N to T1 (NS) and T2 (NS).
- () Install a 1 Meg resistor (brown, black, green) from T1 (NS) and to ground solder lug on socket K (S)
- () Connect a .05 condenser from T1 (NS) to ground solder lug on socket K (NS).
- () Connect a 2.2 Meg (red, red, green) resistor from K6 (NS) to T1 (NS).
- () Connect a length of wire from K6 (S) to B4 (S). Observe wiring dress as shown in pictorial 3.
- () Install a wire from T1 (S) to D3 (S).
- () Connect a wire from T2 (S) to D1 (S).
- () Connect a wire from Q2 (NS) to C2 (S).
- () Twist together two 5" lengths of wire. Connect one end of the twisted pair to the switch solder lugs on rear of panel control D (S).
- () Connect the remaining ends of the twisted pair to Q2 (S) and Q3 (NS).
- () Install line cord through grommet on rear of chassis and knot 2" from the end to provide strain relief.
- () Connect line cord leads to Q1 and Q3 (S).

SPEAKER WIRING

- () Connect a wire from panel binding post 4 (S) to U1 (NS).
- () Connect the red wire of transformer X to U1 (S).
- () Connect a wire from panel binding post 5 (S) to U2 (NS).
- () Connect the blue wire from transformer X to U2 (S).
- () Connect the green lead of transformer X to panel binding post 3 (S).
- () Connect remaining fine wires of transformer X or secondary winding in the following manner.
- () Connect one wire through Y1 (S) and to solder lug under speaker mounting nut (S). Scrape insulation from wire if necessary.
- () Connect a wire from Y2 (NS) to panel binding post 2 (S).
- () Connect remaining transformer X secondary lead to AA2 (NS).
- () Install a 47 Ohm resistor (yellow, violet, black) from AA2 (S) to solder lug under speaker mounting nut (S).
- () Connect a wire from speaker Y2 (S) to panel switch AA1 (S).

LEVEL INDICATOR WIRING

In this assembly, the resistors and necessary connecting wires will be soldered to the round octal socket and then the indicator tube and socket will be snapped into place and the remaining connections completed.

- () Install a 1 Meg resistor (brown, black, green) from 4(NS) to 3 (S) on round octal socket.
- () Install another 1 Meg resistor (brown, black, green) from 5 (NS) to 8 (NS) on round octal socket.
- () Connect a 4" length of twisted hookup wire to round octal socket 2 (S) and 7 (S).
- () Connect a 5 inch length of hookup wire to 4 (S) of the octal socket.
- () Connect a 5 inch length of hookup wire to 5 (S) of the octal socket.
- () Connect a 5 inch length of hookup wire to 8 (S) of the octal socket.

- () Install the 1629 tube in the socket and snap the base of the tube into the spring mounting clip in such a manner that allows the end of the tube to project slightly through the panel opening provided. The socket keyway should be pointed towards the chassis.

In the remaining wiring steps involving the connections from the beam indicator socket to the T-3 chassis, allow sufficient lead lengths that will permit removal of the tube from its spring base clamp. Dress wiring as shown in pictorial 3.

- () Connect the twisted pair of filament wires from the round octal socket to J2 (S) and J7 (S).
- () Connect the lead from lug 4 of the round octal socket to one lug terminal strip R (S).
- () Connect the wire from lug 5 of the round octal socket to B8 (S). Dress this lead as shown in pictorial 3.
- () Connect the wire from lug 8 of the round octal socket to a ground solder lug on socket K (S).

This completes instrument wiring and the panel knobs can now be installed. With a small screw driver, install the set screws in the pointer knobs.

Panel controls A, B and D should all be rotated to extreme counterclockwise position. The pointer knob for the gain control should be tightened on the shaft at the rotation starting point.

The switch pointer knob should be tightened on the shaft at the TRACER position.

The wattmeter knob should be tightened on the shaft at the OFF position.

Install a 12C8 tube in socket F, a 12SH7 tube in socket G, a 12A6 tube in socket J and a 6X5 rectifier tube in socket K.

The aluminum handle should be fastened to the top of the cabinet by using the screws provided. The four rubber mounting feet should be slipped into the mounting holes on the bottom of the cabinet with the flat surface on the outside. The instrument and cabinet are now ready for final assembly but preliminary tests should be made before installation. Chassis installation merely requires that the sheet metal screws be installed in the rear of the cabinet to engage the holes provided in the rear of the chassis. Then by tightening the screws, the chassis and panel are drawn into proper alignment with respect to the cabinet. Be sure that the panel edge properly fits the cabinet flanges.

PROBE ASSEMBLY

- () Place the probe insert terminal board as shown and mount a .02 μ f condenser by placing the leads through holes A and B. The black band faces hole A. The lead through hole A should be bent forward and the other lead toward the unused hole.
- () Mount the crystal diode in a similar manner, placing the leads through holes B and C. The end marked with a band or designated as the cathode should face hole C. Twist the wires coming through B together and solder. Avoid excessive use of heat as otherwise the diode may become damaged. The use of a damp cloth or pliers to quickly quench or remove the heat from the connection is advisable. Cut off the excess wire leaving about 1/4" appearing through hole B. Bend these wires toward the unused hole to lock the parts in place.
- () Install a 1 megohm resistor (brown-black-green) with leads through holes C and D.
- () Mount a 47 K Ω resistor (yellow-violet-orange) with leads through holes C and E. Twist the wires coming through hole C together and solder, observing the previously mentioned cautions regarding excess heat. Cut wires to a length of 1/4" and bend over to lock parts in place.
- () Place a length of flat braid and the large shielded insulated cable through the black probe end. Remove 1" of black outer insulation. Push the braid back until a bulge develops near the end of the black insulation. Bend the end over, poke a hole in the shield braid with a sharp tool and pull the center conductor through. Bend the shield braid and flat braid back together over the flat portion of the probe end and solder together. Make sure that the two braids are as flat as possible or it will be difficult to install the probe body.

NEED EYELETS

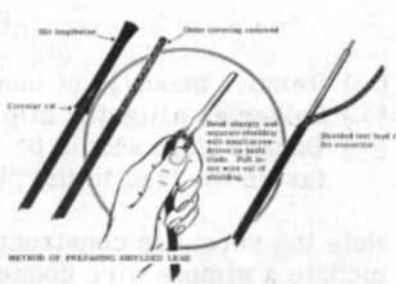
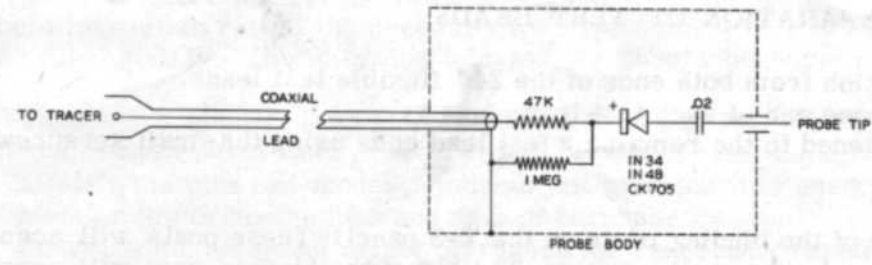
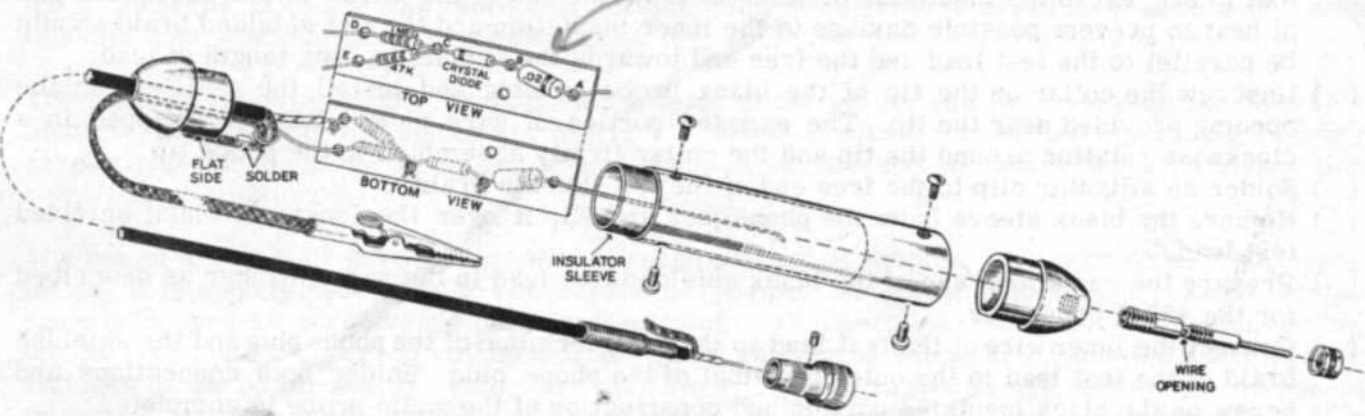

- () Fit the insulator strip tight against the probe end and solder the wire coming through hole D to the two braids near the center conductor.
- () Cut the center conductor to length sufficient to reach the lead coming through hole E. Strip away 3/16" of insulation and solder the center conductor to the wire through hole E. Cut off all excess wire.
- () Install the insulator sleeve in the probe body and slip the entire assembly over the insulator board and probe end. Secure with two self tapping screws.
- () Insert the phone tip in the red probe end. Tighten securely and remove the collar on the phone tip. Push the long wire of the .02 μ f condenser through the hole in the phone tip and secure the front probe end with the remaining two self tapping screws. Wrap the wire around the probe tip and replace the collar.
- () Solder an alligator clip to the free end of the flat flexible braid.
- () At the opposite end of the cable, push the microphone connector spring over the cable with the smallest diameter facing out as shown. Strip away 1" of the black outer insulation. Push the shielding braid back and pull the center conductor through the side of the shielding as before. Bend the shielding over the spring. Strip about 3/16" of insulation from the center conductor and tin the exposed wire. Slide the spring and wire assembly into the body of the connector, making sure that the center wire comes through the holes in the center of the connector. Tighten the set screw on the connector body and solder the wire appearing through the hole. Cut off any excess wire.

AUDIO PROBE ASSEMBLY

- () Remove about 3" of the black insulation from one end of the remaining length of 36" black shielded test lead.
- () From the same end of the shielded test lead, remove about 1" of the shielded braid.
- () Next, expose about $\frac{1}{2}$ " of the bare inner conductor.
- () Solder a length of flat shielded braid to that portion of the exposed shielding on the test lead that is nearest to the insulation or farthest from the end of the wire. Avoid excessive use of heat to prevent possible damage to the inner insulation and the flat shielded braid should be parallel to the test lead and the free end towards the remaining long length of lead.
- () Unscrew the collar on the tip of the black probe housing and install the test lead in the opening provided near the tip. The exposed portion of wire should then be wrapped in a clockwise rotation around the tip and the collar firmly assembled to the probe tip.
- () Solder an alligator clip to the free end of the flat flexible braid.
- () Remove the black sleeve from the phone jack and slip it over the length of black shielded test lead.
- () Prepare the remaining end of the black shielded test lead in the same manner as described for the 432-1 connector.
- () Connect the inner wire of the test lead to the inner terminal of the phone plug and the shielded braid of the test lead to the outer terminal of the phone plug. Solder both connections and screw on the black insulated portion and construction of the audio probe is completed.

PREPARATION OF TEST LEADS

- () Remove about $\frac{1}{2}$ " of insulation from both ends of the 24" flexible test leads.
- () Solder an alligator clip to one end of each test lead.
- () Banana plugs should be fastened to the remaining test lead ends using the small set screw to fasten the lead to the plug.

Note the versatile construction of the binding posts on the T-3 panel. These posts will accommodate a simple wire connection in the usual manner. The top of the binding post will accommodate a banana plug. Spade lug terminals can also be attached to the binding posts and alligator clips will fit into the top of the binding post or can be clipped partially to the top of the binding post. The design of the binding posts will permit utilization of other shop test leads for specialized application of this instrument.

IN CASE OF DIFFICULTY

When properly constructed, the T-3 Visual, Aural Signal Tracer should be capable of performing the following preliminary tests. The instrument should be turned on and after a normal fifteen or twenty seconds of operation, the level indicator tube will display a characteristic green color. This will indicate that the power supply system is functioning. The panel switch should be set to the "Tracer" position and gain control advanced to near maximum. Both the RF and Audio probes should be connected to the panel for these tests. The RF panel switch should be in the on position and the speaker should also be in the on position. Touching the tip of the RF probe should produce a loud humming sound from the Signal Tracer speaker and also will produce a closing of the shadow angle in the electron beam level indicator tube. Touching the tip of the audio probe should produce a much lower output buzzing or humming sound and a corresponding reduced action of the electron beam indicator tube shadow angle. In event your instrument is not capable of performing these preliminary tests, may we suggest that you observe the following procedure:

First of all, quickly check all components through visual inspection for a possible condition of overheating. If any of the resistors become excessively hot, the instrument should be turned off before proceeding with further tests. Disconnect the RF probe and touch the grid cap of the 12C8 tube. Be sure that the RF panel switch is in the on position and that maximum gain setting

is being used. If a loud buzz or hum is heard in the speaker, this would indicate that the fault lies in the construction of the RF probe and this particular assembly should be very carefully rechecked.

Assuming that no signal output is heard from the speaker, the chassis should be turned over and the #3 terminal of panel control A touched with the finger. Correct operation would be indicated by a relatively low buzz or hum in the speaker. Lack of operation could be due to a faulty tube particularly if the panel level indicator is functioning properly. The tube to suspect would be the 12C8. After a few moments of operation, the 12C8 and the 12SH7 tubes will become warm to the touch. The 12A6 and 6X5 tubes will become quite hot and some precaution should be taken to avoid a burn when touching these tubes.

The most common mistakes made in instrument construction can be classified as incorrect identification and circuit placement of resistors and condensers. All wiring should be very carefully checked and the mounting of parts should be checked to insure that all construction complies with the manual.

The use of a VTVM or a Voltmeter will be found extremely helpful. To make voltage measurements, it is merely necessary to connect the negative or black test lead to the chassis, as the chassis is used for a reference point in determining all operating voltages. On the schematic, the correct plate and screen voltages of all three amplifying tubes are indicated. The proper voltages of the power supply system are also shown. Due to variation in line voltage, component tolerance and tube operating characteristics, it would be reasonable to allow a tolerance of plus or minus 15 percent from the voltages stated.

Should inspection reveal the necessity for replacement of a component, write to the Heath Company immediately. The following information should be supplied in all cases:

- A. Thoroughly identify the part in question by using the part number and description found in the manual parts list.
- B. Identify the type and model number of kit in which it is used.
- C. Mention the order number and date of purchase.
- D. Describe the nature of defect or reason for requesting replacement.

The Heath Company will promptly supply the necessary replacement. Please do not return the defective component until specifically requested to do so. Do not under any circumstances dismantle the component in question as this will void the guarantee. If tubes are to be replaced, pack them carefully to prevent breakage in shipment as broken tubes are not eligible for replacement.

CIRCUIT DESCRIPTION

The Model T-3 Signal Tracer is a transformer operated, three stage, high gain instrument that permits visual observation of the signal as well as the usual aural indication. The circuit features dual input channels that can be classified as RF or high gain input and audio or low gain input. The gain control in the grid circuit of the second or low gain stage effectively controls both channels. A grid shorting switch has been incorporated in the high gain stage so that tube noise will not interfere with low gain applications of the instrument. Additional features are a built-in wattmeter, noise locator and substitution test speaker and output transformer.

The pentode section of a 12C8 tube is used in the high gain channel. The diode plates are tied together and provide the necessary rectification for the wattmeter circuit. A 12SH7 is used in the second stage and is pentode connected and coupled into the conventional 12A6 beam power output stage. The output stage utilizes a tapped output transformer so that push-pull output transformer connections may be available for substitution purposes. A panel switching arrangement in the grid circuit of the 12SH7 tube allows the grid to be used for low gain Signal Tracer applications or permits the application of a DC test voltage to the low gain probe, so that the components in a circuit can be checked through voltage application. A coupling condenser permits the amplification of the test voltage action in the component under test.

In addition to panel terminals provided for test speaker use, a voice coil switch is available so that the speaker in the Signal Tracer or an external speaker can be used. To prevent erratic output indications and possible damage, a 47 ohm loading resistor is connected across the output transformer secondary.

Wattmeter indication is obtained by placing the device under test in series with the primary of a separate current transformer. The voltage developed across the secondary is then rectified by the diode plates of the 12C8 and measured in terms of a calibrated wattmeter scale.

A four section electrolytic filter condenser is used to provide maximum filtering for the necessary hum free operation of this instrument. The inherent hum level is extremely low and the hum heard while using the high gain or RF input can be classified as grid hum. This is understandable when consideration is given to the fact that the probe circuit represents an extreme extension of the input 12C8 grid circuit.

It is reasonable to expect some hum while using the high gain input at maximum setting of the gain control. It is obvious that practically any tube used in the first stage of this instrument will exhibit a certain condition of microphonic operation to some extent. However, it should be possible to use maximum gain without encountering a steady condition of microphonics.

SIGNAL TRACER APPLICATIONS

The Signal Tracer is one of the simplest yet most effective instruments the service man can use for rapid, accurate trouble shooting in radio and TV circuits. In order that its operation be simplified, control manipulation should be held to an absolute minimum and of course this simplicity of operation demands that the tracer be of the untuned type. A high gain channel has been incorporated in the circuit which will permit the investigation of RF, oscillator and IF circuits in AM and FM radios as well as TV receivers. A special demodulator probe incorporating a Germanium diode, a blocking condenser and anti-loading resistor is used for this work.

This instrument features a number of definitely useful applications which will permit the service man to quickly locate and diagnose the difficulty being experienced in the circuit under investigation. Many of the tests will be performed automatically and will require only a few seconds of the service man's time. It is earnestly suggested that the builder thoroughly familiarize himself with all phases of instrument operation so that maximum benefits can be realized from the investment in this kit.

The procedure to be followed when using the T-3 Signal Tracer in service work will be outlined in a general manner. Obviously, through familiarity with its operation and use, the service man will develop a pattern of instrument use that will meet his particular requirements. Therefore the suggested instrument used should be construed as general application and does not necessarily represent the limits of the Signal Tracer operation.

RF SIGNAL TRACER

To use the Model T-3 as an RF signal tracer, the RF probe must be connected to the RF screw type panel connector. The panel function switch should be set to the "Tracer" position. The RF switch to the ON position and the gain control advanced to approximately two thirds of its maximum rotation. The speaker panel switch should be in the ON position and since the Model T-3 Signal Tracer does permit visual observation of the signal, the user of the instrument may find it more convenient in certain applications to leave the speaker switch in the OFF position. The indicator tube on the panel will permit an approximate indication of signal level that is being observed. If the signal is extremely weak, the gain control of the tracer will allow sufficient reserve gain so that the signal can be observed quite readily. The overall gain of the Heathkit Model T-3 Visual, Aural Signal Tracer is adequate to permit direct observation of the actual transmitted signal of even a weak station.

To illustrate the use of this instrument, we may assume that a radio receiver is under test with the specific complaint of low volume. Since the receiver is in operating condition, it could be turned on and tuned to a familiar station. The volume control of the receiver should be reduced so that the speaker output will not interfere with the Signal Tracer results. The flexible ground lead of the RF probe should be clipped to the B minus or ground circuit of the receiver. The test probe can then be applied directly to the antenna terminal or to the antenna loop. Sufficient gain should be used to permit an indication of the signal level that is present. The probe can be moved through the input circuit to the antenna trimmer and tuning system to the grid of the mixer or converter tube. The path of the signal can be traced progressively from the plate of the mixer tube and to the IF stage grid. The output of the IF stage can be checked by applying the probe directly to the IF tube plate and then to the IF output transformer secondary. The signal can logically be traced through any additional IF stages that may be present and into the detector stage.

During these tests, an approximate estimation of gain per stage can be made and the degree of gain that is expected in a circuit can usually be determined through previous experience in making similar tests. It would be well to remember that in some cases, the RF probe may allow a slight detuning effect when applied to the tuned circuits and may induce oscillation. Rather than attempt to correct the receiver circuit for this condition, it would be advisable to advance the probe to the following test point and if a good signal indication is present, it would be reasonable to assume that the circuit is functioning properly.

The same general procedure can be used in checking RF and IF stages in radio and TV circuits. Obviously since the actual signal is the prime factor of consideration, the Signal Tracer will detect the presence or absence of a desired signal regardless of the type of circuit involved.

AUDIO SIGNAL TRACING

After detection has taken place in the receiver circuit, the use of the RF probe is not required and the audio probe should be used. To eliminate any possible confusion, the RF or high gain panel switch should be moved to the OFF position. The audio probe consists of a simple shielded probe and uses the low gain channel of the Signal Tracer. Here again, the same general conditions previously described apply to the use of the indicator tube and the speaker. From the detector stage, the signal can be traced through various coupling circuits through audio stages and the output transformer. These tests can be made very quickly and will conclusively indicate any circuit fault which would be evident by loss of signal or gain in succeeding stages. Faulty volume controls can be detected and open or intermittent audio coupling condensers can be quickly spotted.

It is interesting to note that the Model T-3 Signal Tracer will detect the presence as well as the absence of signal. For example, it is common practice to use a high capacity condenser in the cathode circuit of the output stage to bypass the bias resistor. In event this condenser is open, there will be a definite indication of signal at the cathode whereas a good condenser would bypass the signal to ground in the desired manner.

As a signal is traced through the audio system, the signal level will be extremely high and it will be necessary to reduce the setting of the Signal Tracer gain control. A definite reduction in gain will be noted as the probe is moved from the primary winding of the output transformer to the secondary winding. This, of course, represents an entirely normal behavior pattern.

WATTMETER

By the addition of a few circuit components, the T-3 Signal Tracer will serve as an extremely useful wattmeter. To use the instrument as a wattmeter, it is merely necessary to set the panel function switch to the wattmeter position and since amplifier gain is not required for this purpose, the gain control should be reduced to minimum. The AC plug of the receiver under test should be plugged into the AC receptacle provided on the panel of the Signal Tracer. The receiver should then be turned on and allow a few seconds for normal operating conditions to be

reached. The wattmeter control should then be adjusted for closing of the shadow angle in the indicator tube without allowing overlapping to take place. The power consumption can then be read directly on the calibrated wattmeter scale. Since it is common practice for receiver manufacturers to indicate watts consumption on the chassis label, it can be quickly determined whether or not the power consumption is normal. It would be reasonable to allow a tolerance of approximately ten percent.

The value of this test can readily be appreciated when consideration is given to the fact that any overload condition in the voltage distribution system of the receiver will definitely reflect in a relatively higher wattage consumption rating. For example, a shorted screen bypass condenser or a shorted filter condenser will provide a definite indication. Naturally when this condition is encountered, the receiver should be turned off and the source of the trouble located through the use of an ohmmeter and corrected before proceeding with further tests. A wattage consumption reading less than the indicated rating could conceivably be due to an open filament string in a transformerless type radio receiver or TV receiver. This particular test can be very quickly made and will produce a definite indication of overall receiver power consumption.

When using the wattmeter, some consideration should be given to the a-c line voltage. Variations in a-c line supply will cause corresponding variations in wattmeter indication. For example, a 200 watt incandescent lamp will check very close to the 200 watt figure when it is operated at 120 volts which, of course, is the normal rated voltage for the lamp. The same lamp at 110 volts actually requires only 182 watts. The wattmeter in your signal tracer has been calibrated at a 117 volt reference level as this represents the average voltage level usually maintained.

The useful range of wattmeter calibration will adequately measure the power consumption of small table model radio-receivers through the larger radio phono combinations as well as TV receivers. Bear in mind that in radio and phono combinations, the manufacturers label indicating wattage consumption refers to the combined operation of the radio and the phono mechanism and, therefore, suitable allowances must be made if power consumption measurements are to be made under these conditions. Quite frequently a radio and phonograph will be used in combination with a TV receiver and the wattage consumption will be for all three units.

An assortment of incandescent lamps can be used in various combinations to check the wattmeter calibration. It will be necessary to use a variac or Step-up transformer in order to simulate 120 volt line conditions for which these lamps are rated.

NOISE LOCATER

A rather unique and definitely useful application of the T-3 Signal Tracer is its ability to locate noisy and intermittent components in various circuits. Basically the noise locating feature of the Signal Tracer permits the application of a DC test voltage to any component in the receiver circuit and the action of the DC voltage in the component is picked up and amplified in the Signal Tracer itself. This DC voltage of approximately 175 to 200 volts is available at the tip of the audio probe and of course the ground clip of the audio probe provides the necessary return circuit. Some precaution should be observed so that the service man will not encounter a relatively harmless shock hazard. The circuit arrangement is such that even under a dead short circuit condition of the ground clip to the test probe, the current drain will not exceed one mil and therefore the possibility of damage to a receiver component is eliminated. To use the T-3 as a noise locator, the following conditions should be observed.

First of all it is important that the receiver to be checked should be disconnected entirely from the AC supply line as all tests will be made on an inoperative receiver. The audio or low gain probe is used for this test and the panel function switch set to the Noise setting. As previously mentioned, a DC voltage in the order of 160 volts is now present between the probe tip and the ground clip.

To illustrate an example of usage, the ground clip should be connected to a B plus supply point in the circuit. The test probe is then applied directly to the plate terminal of an IF tube. The gain control of the Signal Tracer should be at near maximum position. As the test probe is applied to the terminal of the IF tube, a sharp click will be heard in the Signal Tracer speaker. A good, clean click would indicate proper circuit continuity and operation. If there is any frying or crackling sound present, it would be reasonable to assume that some difficulty is being experienced along the circuit and then the test probe should be moved along each portion of the circuit in order that each component may be progressively checked. As the test probe is moved along through coils, resistors and other components toward the ground clip, it is quite likely that at some point the noise will disappear. When this condition occurs, the preceding step should be repeated and further investigation made of the particular circuit involved for a possible faulty component.

Noisy resistors will very definitely show up as a buzzing or crackling sound. The same condition holds true for a cold or rosin soldered connection in the receiver wiring. Shorted turns in IF transformers will also be evident by the noise content. The important thing to remember is that a satisfactory component will permit a sharp click to be heard in the speaker whereas a faulty component will result in a characteristic objectionable noise.

Obviously, the test voltage can be applied to any component in the receiver. For example, if an audio coupling condenser is suspected, the voltage can be applied across the condenser terminals and then the condenser jiggled or prodded to determine whether or not a noisy or intermittent condition may be present. Noisy volume controls or tone controls can be detected and of course the same condition holds true for the rotor section of variable condensers. Voltage can be applied to the condenser while it is being rotated and any shorting will be quickly evident. Of course, it will be necessary to disconnect any external circuit wiring connected to the condenser terminals.

Transformer windings that are faulty will also show up as noise in the Signal Tracer speaker. The continuity of windings can be checked and any leakage from winding to frame can be quickly determined.

There is practically no limit to the variety of useful applications afforded by this feature of the Signal Tracer, and it is suggested that the service man further investigate other test procedures in which the application of a DC voltage to a component in conjunction with a high gain amplifier will permit observation of the voltage action.

An additional alligator clip has been packed with your kit. This alligator clip will fit nicely on the tip end of the RF probe and will allow the probe to be clipped to any given circuit point when the test involved requires more than just a mere touching of the terminal. The alligator clip can be slipped on or off the probe at your convenience.

PANEL CONNECTIONS

For additional flexibility of operation, the Signal Tracer panel features five binding posts. These binding posts differ slightly from the conventional type in respect that it is possible to insert a banana plug into the top of each jack. They will also accommodate alligator clips, spade lugs and conventional hookup wire. Test leads such as used in the VTVM can be used interchangeably with this instrument when required. The panel arrangement of the T-3 Signal Tracer will permit the utilization of other shop equipment for test procedure. For example, a VTVM can be connected either from B plus to P or from P to common or ground terminal. The VTVM would of course be switched to the AC position and the calibrated scale of the VTVM could be read directly for precise measurements during alignment procedure and gain calculations. The same terminals can be used for connecting to the vertical input of an oscilloscope. For additional amplitude, the vertical input of the scope can be connected across the full primary of the Signal Tracer output transformer and of course this would involve the use of both binding posts marked P. Obviously, the output transformer secondary connections could be utilized if the test requirements required the elimination of the DC voltage present in the primary circuit. A reduction in gain indication should be expected.

TEST SPEAKER

In service work, it is frequently to remove the chassis of a radio or TV receiver to the repair shop in order to properly complete repair work. In practically every instance, the speaker is a separate piece of equipment and in some cases is installed in a rather inaccessible cabinet location. With the Model T-3 Signal Tracer at your disposal, it is not necessary to remove the speaker in view of the fact that the output transformer and speaker are available as test or substitution units. In the majority of cases, the original receiver circuit requirements specify the use of a permanent magnet type speaker and therefore the substitution can be very readily made. The advantage of using this feature of the Signal Tracer is readily apparent when consideration is given to the time and effort conserved by eliminating the necessity for speaker removal and re-installation on every service job. In addition, the possibility of damage to the speaker cone during the handling process is eliminated.

AUDIO SYSTEM

Quite frequently the service man will be called upon to service automatic record changers or phono mechanisms and of course this equipment is usually removed from the cabinet of the receiver and transported to the service shop. While making mechanical repairs or adjustments to the changer mechanism, it is frequently desirable that the output of the phono cartridge be checked and actual conditions of tone reproduction simulated. Here again, it is a relatively simple matter to connect the low gain input of the T-3 Signal Tracer to the output cable of the record changer. The changer output as heard in the speaker of the Signal Tracer will permit detection of any irregularity in mechanical operation such as turntable "wow" or "thump" or any objectionable noise that could be transmitted through the phono cartridge and reproduced as an undesirable condition.

This same procedure could be used in checking microphones and musical instrument pickups and here again the results obtained are interpreted on the basis of comparisons made with previous tests on similar equipment. In an emergency, the Signal Tracer could be used as a high gain, low power public address amplifier. Of course, it could be used in checking FM tuners or other equipment requiring the use of an audio system.

OUTPUT METER

The Model T-3 Signal Tracer can be used as an output meter merely by connecting the low gain to some point of the audio system in the receiver and regulating the amount of gain to permit usable action of the eye indicator. Then while performing alignment adjustments, the amount of gain or loss experienced in following a specific alignment procedure can be quickly determined. The Heathkit Model T-3 Signal Tracer will prove itself an extremely useful and versatile addition to any service shop. It is earnestly suggested that the user thoroughly familiarize himself with all phases of its operation so that he may obtain maximum benefits from his investment in this instrument.

SERVICE

In event continued operational difficulties of the completed instrument are experienced, may we remind you that the facilities of the Heath Company Service Department are at your disposal. Your instrument may be returned for inspection and repair for a service charge of \$3.00 plus the cost of any additional material that may be required. **THIS SERVICE POLICY APPLIES ONLY TO COMPLETED INSTRUMENTS CONSTRUCTED IN ACCORDANCE WITH THE INSTRUCTIONS AS STATED IN THE MANUAL.** Instruments that are not completed or instruments that are modified will not be accepted for repair. Instruments showing evidence of acid core solder or paste fluxes will be returned, not repaired.

The Heath Company is willing to offer its utmost cooperation to assist you in obtaining the proper operation of your instrument and therefore the factory repair service is available for a period of one year from the date of purchase.

NOTE: Before returning this unit, be sure that all parts are securely mounted. Attach a tag to the instrument, giving name, address and trouble experienced. Pack in a rugged container, preferably wood, using at least three inches of shredded newspaper or excelsior on all sides. Do not ship in the original kit carton as this carton is not considered adequate for safe shipment of the completed instrument. Ship by prepaid express, if possible. Return shipment will be made by express collect. Note that a carrier cannot be held liable for damages in transit if **PACKING IN HIS OPINION** is insufficient.

SPECIFICATIONS

All prices are subject to change without notice. The Heath Company reserves the right to discontinue instruments and to change specifications, at any time without incurring any obligation to incorporate new features in instruments previously sold.

WARRANTY

The Heath Company limits its warranty of parts supplied with any Heathkit (except tubes, meters and rectifiers, where the original manufacturer's guarantee only applies) to a period of three (3) months from the date of purchase. Replacement will be made only when said part is returned postpaid, with prior permission and in the judgment of the Heath Company was defective at the time of sale. This warranty does not extend to any Heathkits which have been subjected to misuse, neglect, accident and improper installation or applications. Material supplied with a kit shall not be considered as defective, even though not in exact accordance with specifications if it substantially fulfills performance requirements. This warranty is not transferable and applies only to the original purchaser. This warranty is in lieu of all other warranties and the Heath Company neither assumes nor authorizes any other person to assume for them any other liability in connection with the sale of Heathkits.

The assembler is urged to follow the instructions exactly as provided. The Heath Company assumes no responsibility for the operation of the completed instrument, nor liability for any damages or injuries sustained in the assembly or operation of the device.

HEATH COMPANY
Benton Harbor, Michigan

WIRING OF EXPORT TYPE 110/220 VOLT POWER TRANSFORMERS

These transformers have a dual primary for use on either 110 Volts or 220 Volts Wire as shown.

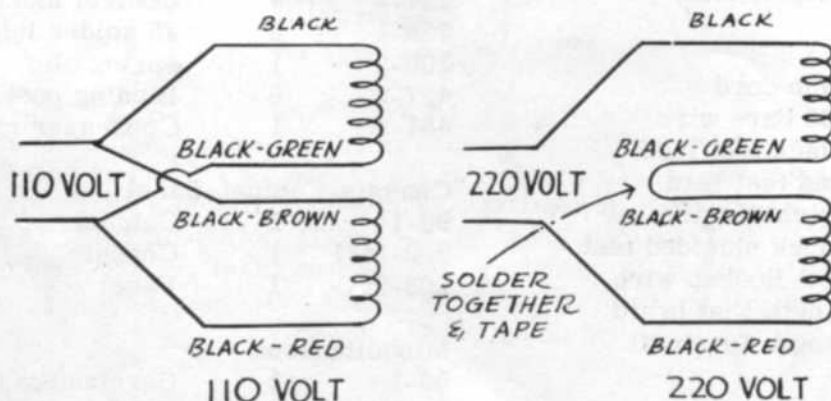

PARTS LIST

MODEL T-3

PART No.	PARTS Per Kit	DESCRIPTION	PART No.	PARTS Per Kit	DESCRIPTION
Resistors			Sockets-Terminals-Plugs		
1-1	1	47 Ω	260-1	5	Alligator clip
1-6	1	470 Ω	260-2	1	Grid clip
1-15B	1	1000 Ω 2 watt	431-1	2	1 lug terminal
1-20	1	10 K Ω	431-2	2	2 lug terminal
1-24	1	33 K Ω	431-3	1	3 lug terminal
1-25	1	47 K Ω	432-1	1	Connector
1-26	1	100 K Ω	432-3	1	Connector
1-32	1	390 K Ω	434-2	4	Octal socket
1-33	2	470 K Ω	434-4	1	Octal socket
1-35	6	1 megohm	434-20	1	110 volt socket
1-37	4	2.2 megohm	436-1	1	Phone jack
Condensers			70-2	1	Insulator sleeve, black
23-2	5	.005 600 volts	70-3	1	Insulator sleeve, red
23-6	1	.02 600 volts	70-4	1	Insulator sleeve, acetate
23-10	4	.05 600 volts	75-10	1	Insulator insert board
25-4	1	10 μ fd at 25 volts	438-3	1	Phone plug
25-21	1	20-20-20-20 at 450 volts	438-M8	2	Banana plug-sleeve assembly
Controls-Switches			439-M5	1	Black test probe
10-32	1	1 megohm	459-M2	1	Red probe tip end (tapped)
19-12	1	50 K with switch	459-M3	1	Black probe tip end
60-1	2	SPST slide switch	476-M8	1	Probe body-drilled
63-40	1	2 pole 3 position	477-3	1	Solderless phone tip
Tubes			Hardware		
411-17	1	6X5GT	100-M16	5	Thumbscrew
411-21	1	12A6	250-1	4	Self tapping screw
411-22	1	12C8	250-8	2	#6 sheet metal screw
411-27	1	12SH7	250-9	28	6-32 x 3/8" screw
411-30	1	1629	250-18	2	8-32 screw
Transformers			250-19	2	10-24 handle screw
51-10	1	Output Transformer	250-22	3	Set screw
54-15	1	Power transformer	250-25	2	Screw
54-16	1	Watt meter transformer	252-3	34	6-32 nut
Knobs-Grommets-Feet			252-4	2	8-32 nut
73-1	6	3/8" grommet	252-7	5	Control nut
261-1	4	Rubber feet	253-1	4	Flat fiber washer
462-M11	3	Pointer knob	253-2	5	Shoulder fiber washer
Wire-Spaghetti			253-10	4	Control nickel washer
89-1	1	Line cord	254-1	28	#6 lockwasher
340-2	1	#20 bare wire	254-2	2	#8 lockwasher
341-1	1	Black test lead	254-4	5	Control lockwasher
341-2	1	Red test lead	259-1	6	#6 solder lug
342-1	1	Shielded wire	208-2	1	Spring clip
343-2	2	Black shielded test	427-2	5	Binding post base
344-1	1	roll Hookup wire	481-1	1	Condenser mounting wafer
345-1	2	length Flat braid	Chassis-Cabinet-Panel		
346-1	2	length Spaghetti	90-14	1	Cabinet
Miscellaneous			200-M31	1	Chassis
56-1	1	Germanium diode	203-36	1	Panel
209-M1	1	Speaker grill	Miscellaneous		
211-1	1	Cabinet handle	56-1	1	Germanium diode
401-2	1	4" speaker	209-M1	1	Speaker grill
595-43	1	Manual	211-1	1	Cabinet handle

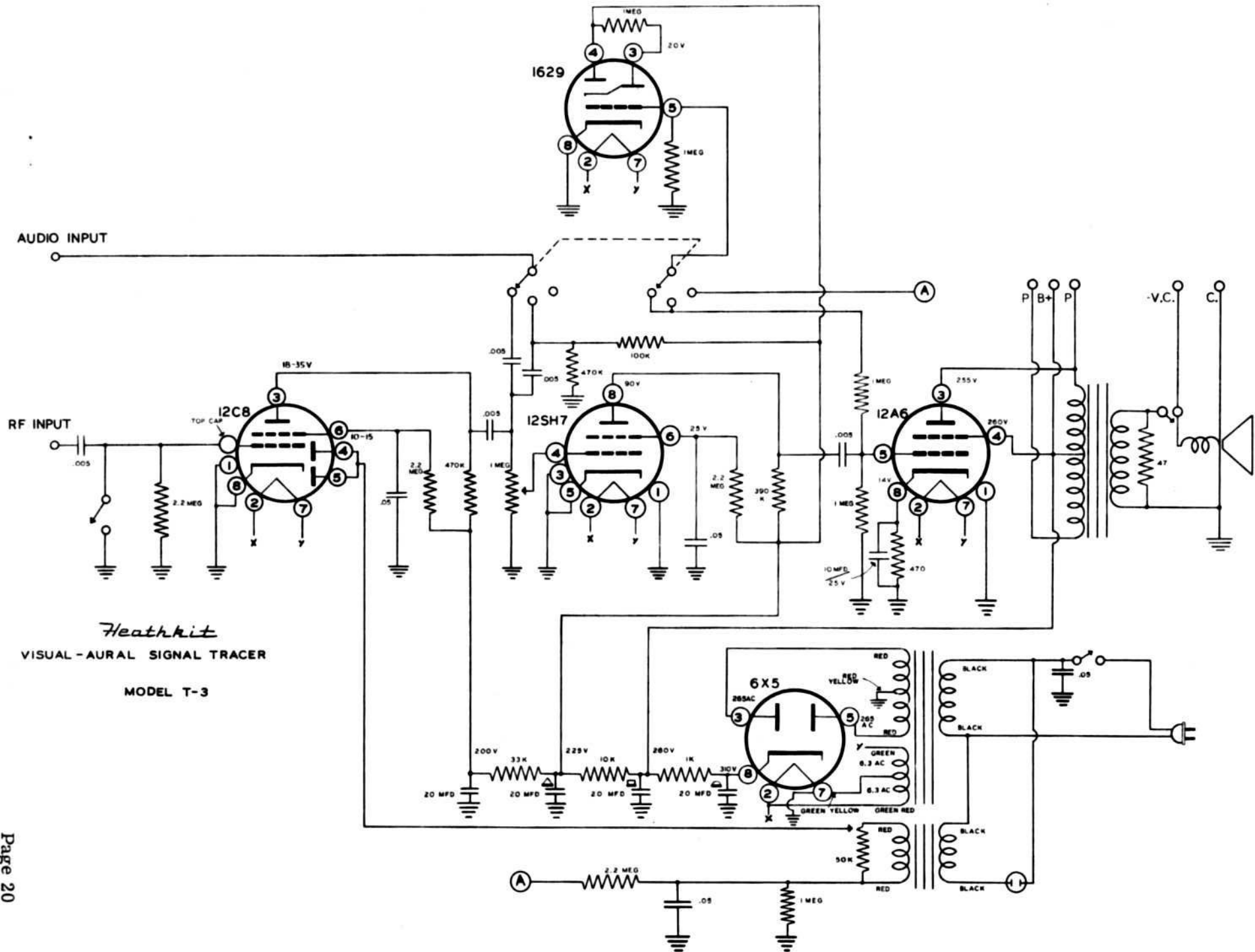

TOP CHASSIS VIEW

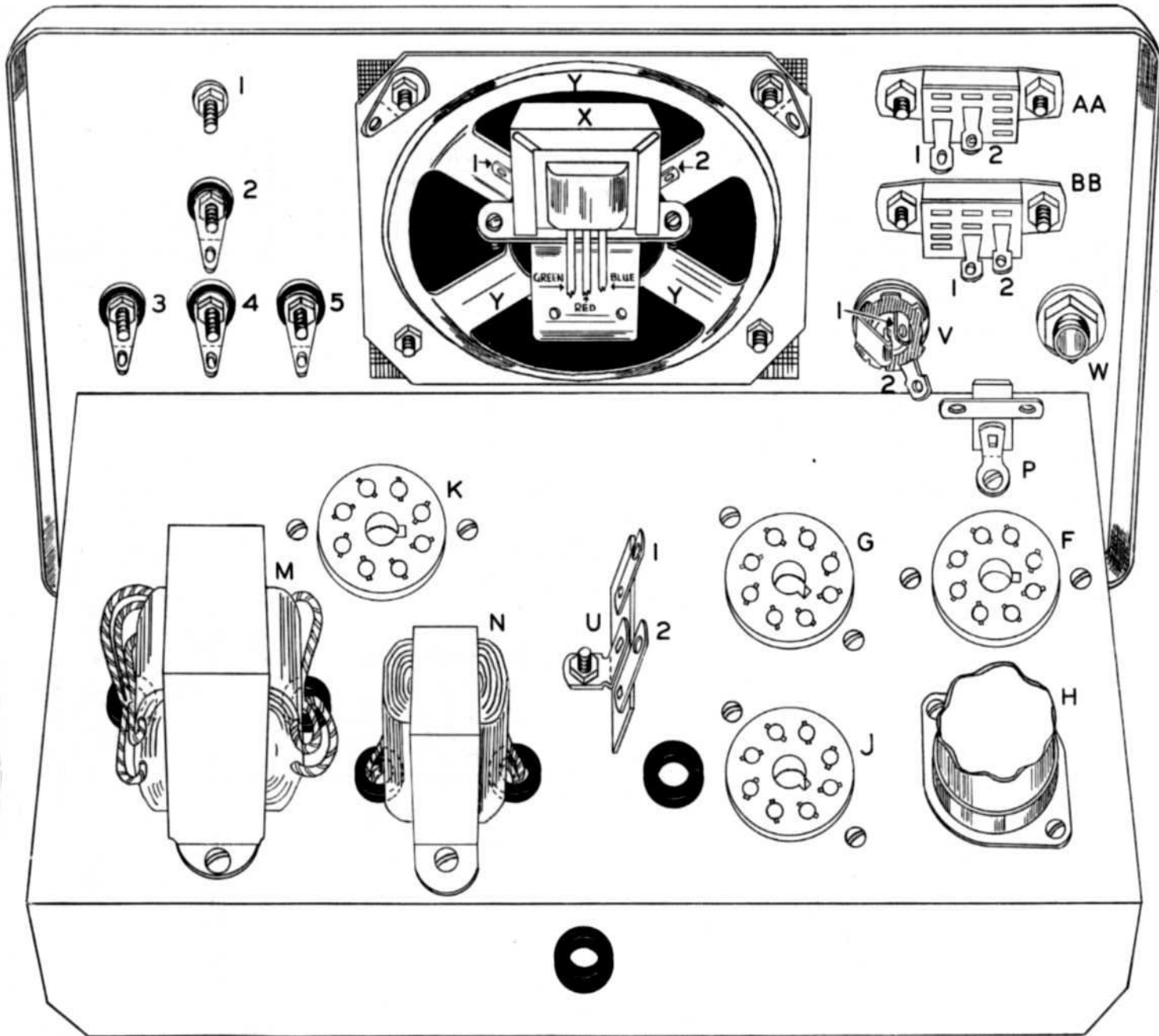

PICTORIAL I

BOTTOM CHASSIS VIEW

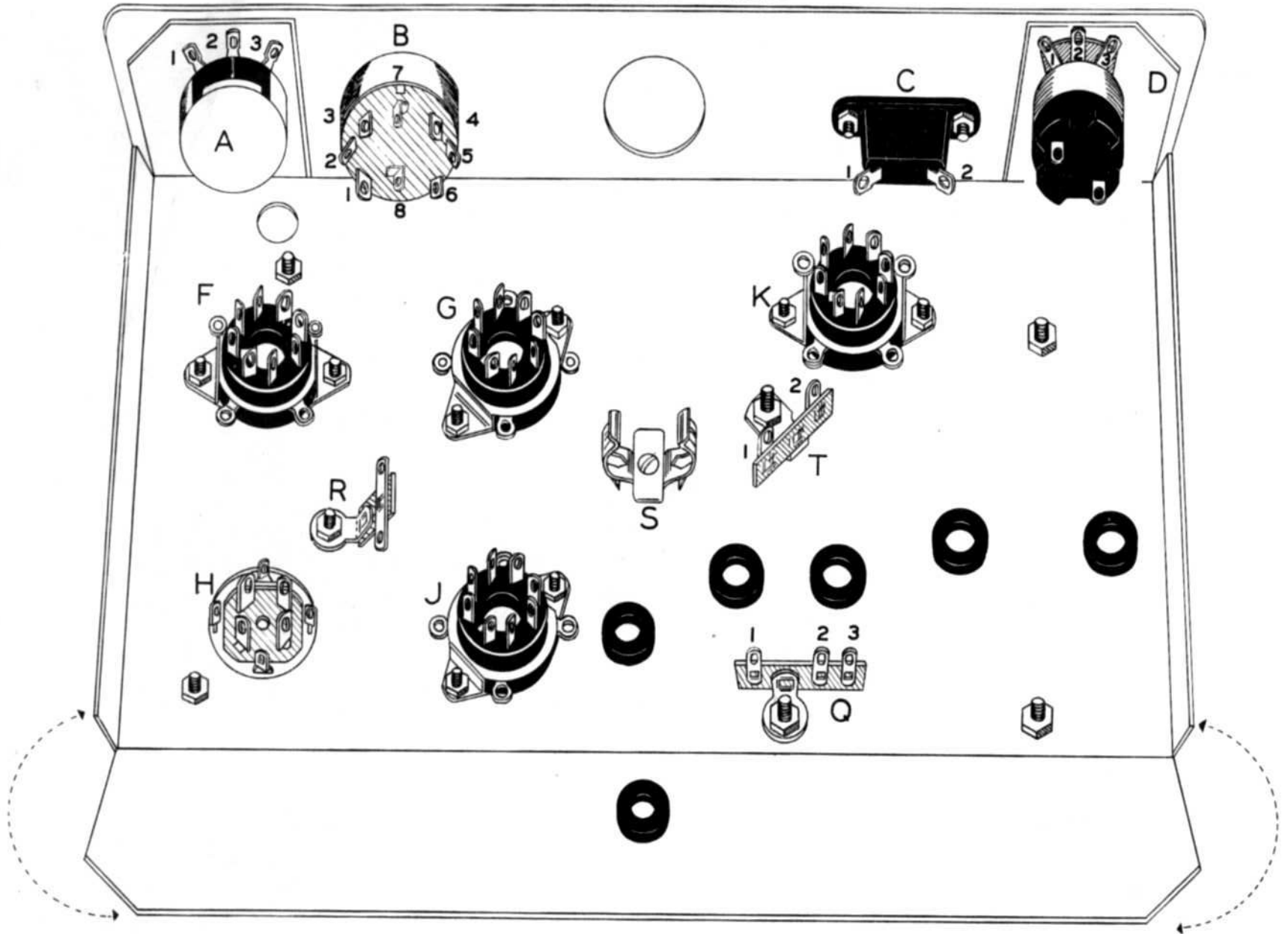

PICTORIAL 2

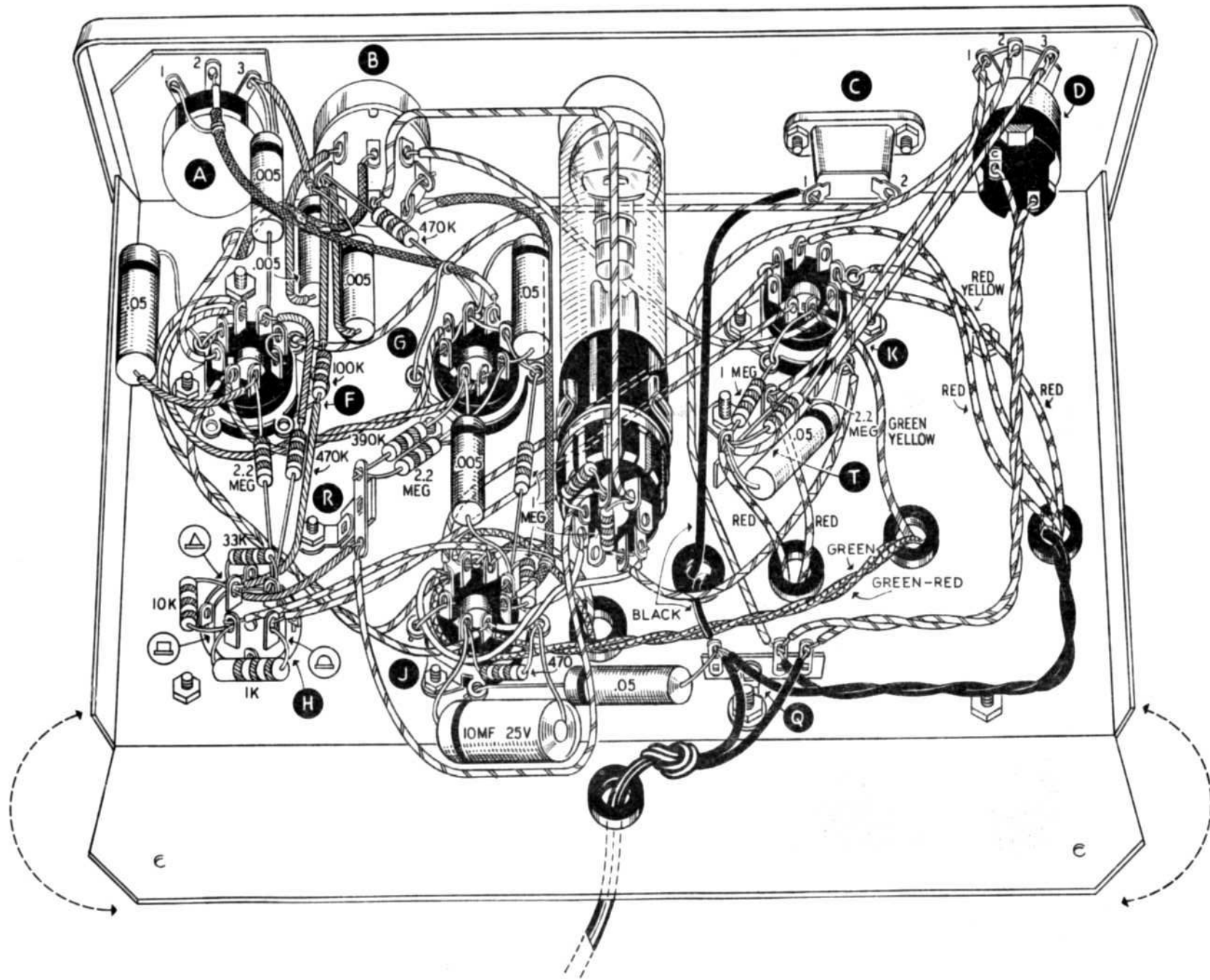

PICTORIAL 3

HELPFUL KIT BUILDING INFORMATION

Before attempting actual kit construction read the construction manual through thoroughly to familiarize yourself with the general procedure. Note the relative location of pictorials and pictorial inserts in respect to the progress of the assembly procedure outlined.

This information is offered primarily for the convenience of novice kit builders and will be of definite assistance to those lacking thorough knowledge of good construction practices. Even the advanced electronics enthusiast may benefit by a brief review of this material before proceeding with kit construction. In the majority of cases, failure to observe basic instruction fundamentals is responsible for inability to obtain desired level of performance.

RECOMMENDED TOOLS

The successful construction of Heathkits does not require the use of specialized equipment and only basic tools are required. A good quality electric soldering iron is essential. The preferred size would be a 100 watt iron with a small tip. The use of long nose pliers and diagonal or side cutting pliers is recommended. A small screw driver will prove adequate and several additional assorted screw drivers will be helpful. Be sure to obtain a good supply of rosin core type radio solder. Never use separate fluxes, paste or acid solder in electronic work.

ASSEMBLY

In the actual mechanical assembly of components to the chassis and panel, it is important that the procedure shown in the manual be carefully followed. Make sure that tube sockets are properly mounted in respect to keyway or pin numbering location. The same applies to transformer mountings so that the correct transformer color coded wires will be available at the proper chassis opening.

Make it a standard practice to use lock washers under all 6-32 and 8-32 nuts. The only exception being in the use of solder lugs—the necessary locking feature is already incorporated in the design of the solder lugs. A control lock washer should always be used between the control and the chassis to prevent undesirable rotation in the panel. To improve instrument appearance and to prevent possible panel marring use a control flat nickel washer under each control nut.

When installing binding posts that require the use of fiber insulating washers, it is good practice to slip the shoulder washer over the binding post mounting stud before installing the mounting stud in the panel hole provided. Next, install a flat fiber washer and a solder lug under the mounting nut. Be sure that the shoulder washer is properly centered in the panel to prevent possible shorting of the binding post.

WIRING

When following wiring procedure make the leads as short and direct as possible. In filament wiring requiring the use of a twisted pair of wires allow sufficient slack in the wiring that will permit the twisted pair to be pushed against the chassis as closely as possible thereby affording relative isolation from adjacent parts and wiring.















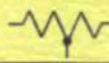



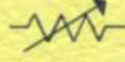





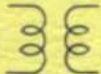
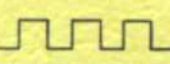
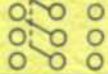

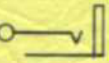



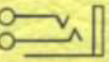

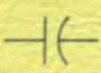

When removing insulation from the end of hookup wire, it is seldom necessary to expose more than a quarter inch of the wire. Excessive insulation removal may cause a short circuit condition in respect to nearby wiring or terminals. In some instances, transformer leads of solid copper will have a brown baked enamel coating. After the transformer leads have been trimmed to a suitable length, it is necessary to scrape the enamel coating in order to expose the bright copper wire before making a terminal or soldered connection.

In mounting parts such as resistors or condensers, trim off all excess lead lengths so that the parts may be installed in a direct point-to-point manner. When necessary use spaghetti or insulated sleeving over exposed wires that might short to nearby wiring.

It is urgently recommended that the wiring dress and parts layout as shown in the construction manual be faithfully followed. In every instance, the desirability of this arrangement was carefully determined through the construction of a series of laboratory models.

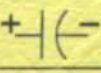
SOLDERING

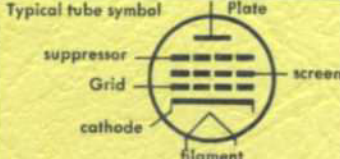
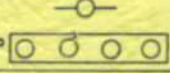
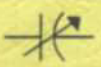
Much of the performance of the kit instrument, particularly in respect to accuracy and stability, depends upon the degree of workmanship used in making soldered connections. Proper soldered connections are not at all difficult to make but it would be advisable to observe a few precautions. First of all before a connection is to be soldered, the connection itself should be clean and mechanically strong. Do not depend on solder alone to hold a connection together. The tip of the soldering iron should be bright, clean and free of excess solder. Use enough heat to thoroughly flow the solder smoothly into the joint. Avoid excessive use of solder and do not allow a flux flooding condition to occur which could conceivably cause a leakage path between adjacent terminals on switch assemblies and tube sockets. This is particularly important in instruments such as the VTVM, oscilloscope and generator kits. Excessive heat will also burn or damage the insulating material used in the manufacture of switch assemblies. Be sure to use only good quality rosin core radio type solder.

Antenna General		Resistor General		Neon Bulb		Receptacle two-conductor	
Loop		Resistor Tapped		Illuminating Lamp		Battery	
Ground		Resistor Variable		Switch Single pole Single throw		Fuse	
Inductor General		Potentiometer		Switch double pole single throw		Piezoelectric Crystal	
Air core Transformer General		Thermistor		Switch Triple pole Double throw		1000 = K	
Adjustable Powdered Iron Core		Jack two conductor		Switch Multipoint or Rotary		1,000,000 = M	
Magnetic Core Variable Coupling		Jack three conductor		Speaker		OHM = Ω	
Iron Core Transformer		Wires connected		Rectifier		Microfarad = MF	
Capacitor General		Wires Crossing but not connected		Microphone		Micro Microfarad = MMF	
Capacitor Electrolytic		A. Ammeter V. Voltmeter		Typical tube symbol 	Binding post Terminal strip		
Capacitor Variable		G. Galvanometer MA. Milliammeter uA. Microammeter, etc.			Wiring between like letters is understood	