

The

# Collins

Collector's Quarterly Magazine

---

Volume 1 Issue 4

Spring 1992

---

*Inside:*

## KWS-1

The care and feeding, and other trivia



# Contents

---

## KWS-1: The care and feeding, and other trivia

Written by Bill Carns, N7OTQ

Page 2

## A look back

KWS-1 advertisements from the 1950s

Page 21



**Publisher/Editor**  
Jay Roman, KBØATQ

**Assistant Editor/Production  
Manager**  
Sharon Bishop

**Technical Editor**  
Dick Uhrmacher, KØVKH

**Data Base Development**  
Dennis Williams, NØMND

**Bookkeeper**  
Joan Roman

**Editorial and Business Office**  
Collins Collector's Magazine  
2465 W. Chicago Street  
Rapid City, SD 57702  
PHONE: 605/341-6831  
FAX: 605/341-1943

---

### On the Cover

General Partridges at the controls of an air-mobile KWS-1, 75A-4. Installed in a DC-6—note the shock mounts and shields.

Printed in the U.S.A. ©1991 The Collins Collector's Quarterly Magazine is published by Collins Collector's Magazine, 2465 W. Chicago St., Rapid City, SD 57702.

Subscription rates: 1 year-\$35 (U.S. residents); \$35 (Canadian residents); and \$75 (other foreign countries). All subscriptions payable in U.S. funds. CCM assumes that such material as letters, new product information, etc., is contributed **gratis**. Requests and information about submitting articles should be directed to the publisher.

# The care and feeding of your KWS-1 and other pertinent trivia

By Bill Carns, N7OTQ



**M**y first exposure to the Collins KWS-1 came in 1955, about the same time that I got my novice license in highschool. I opened my March '55 QST and fell in love. Like many others, that was as close as I got to the real thing until several years ago when an old receiver in my garage lured me back into the hobby.

Prompted by memories of those old ads and one brief demonstration at a professor's house in 1960 (where, by the way, it seemed like he could talk to anywhere he wanted to), I immediately went looking for a used KWS-1 and 75A-4. Three months later I was in the KWS-1 restoration business. That was three years, and several more KWS-1s, ago.

As the interest in Collins gear has increased over the last two years, so has the demand for KWS-1s along with the number of units being brought back into active service.

This has prompted me to share some of the information that I have gleaned from many helpful sources or have developed over the last few years. I'm sure that it is by no means complete. I hope that

others with experience with the KWS-1 will take the time to write down their hints and experiences and send them to Jay or the author where they will be compiled and then made available. The intent is to help preserve the remaining units in as good and as original condition as possible.

There follows a compilation of some historical notes, production information, suggestions and maintenance hints and a list of information/parts sources.

This will probably be the subject of a separate future article, but let me summarize here a brief history of the KWS-1.



**Figure 1.**  
*Bill Carns, N7OTQ's main KWS-1 and 75A-4 operating position.*



**Figure 2**  
*Gene Senti, Project Design Leader during the transfer of the KWS-1 to production, inspects one of the units.*

## **Brief history of Collins KWS-1**

Art Collins' disenchantment with AM and his shift of emphasis to single-sideband accelerated suddenly in the very early 1950's. By 1952, Art had set up what he called his "green room"—his skunk-works for SSB. A number of people worked on various elements of the project. Among them were:

Warren Bruene (employed by Collins from 1939 thru 1984) was the most tenured employee of Collins Radio and was responsible for the preliminary engineering work leading to the selection of the Eimac 4X150 final amplifier tubes,

the development of the RF feedback technique employed, and much of the initial SSB theory work. (Reference 1.) The culmination of this work was in large part responsible for the excellent linearity achieved with the final design.

Walt Zarris (employed by Collins from about 1945 to 1953) was the initial design project leader managing the project until he left. The project was completed and taken to production by Gene Senti (Collins-1942 thru 1972). Production was commenced in 1955.

*Collins* **PROUDLY ANNOUNCES**  
**A NEW STANDARD**  
**in AM, CW and SSB OPERATION**

It took Collins to produce the first really new Amateur communication system, designed expressly for Single Sideband as well as AM and CW operation. Collins new 75A-4 Receiver 32W-1 Exciter or 75A-4 Receiver/30L-1 Transmitter combinations are designed for the most exacting Amateur. Engineering-wise, the equipment meets the high standards Collins has set for military and commercial equipment. Price-wise, the Amateur will get more for his money than ever before. See your nearest Collins distributor for your brochure.

**30L-1**  
**TRANSMITTER**

Collins engineering plus extensive on-the-air tests account for the 30L-1 Transmitter's reliability and optimum performance in SSB, AM and CW operation. The exciter and RF power amplifier are housed in a single receiver size cabinet. The Collins 367A-1 linear RF power amplifier uses two 4X150A's in class AB operation. RF feedback is employed to improve the linearity characteristics of the power amplifier. The 30L-1 incorporates circuit application and components which have been proved in preceding Collins equipment; to note a few, the 70E VFO, the Pi-L output network, extremely accurate VFO dial and the Collins Mechanical Filters. To meet the Amateur's future desire for power increase, Collins 32W-1 Exciter can be modified to a 30L-1 at the factory.

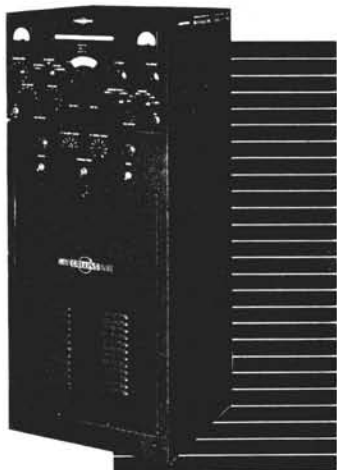

**32W-1**  
**EXCITER**

Designed to meet the requirements of the most discriminating Amateur whether he operates SSB, AM or CW, the 32W-1 Exciter has sufficient output power to drive a high-level power amplifier stage, and together with the 75A-4 Receiver provides the basic needs for a completely engineered Amateur radio installation. Special features of the 32W-1 are dual conversion, a permeability tuned, hermetically sealed VFO, a Single Sideband generator using the Collins Mechanical Filter to provide optimum rejection of the unwanted sideband, RF feedback to assist in reduction of distortion products, selectable sidebands, bandswitching operation on all amateur bands from 3.5 to 30 mc, VOX or push-to-talk operation, AM operation with full carrier and one sideband being transmitted, CW operation with wave shaping for minimum key clicks and transients, FSK operation by using an external audio FSK oscillator, Automatic Load Control (ALC), and unitized construction.

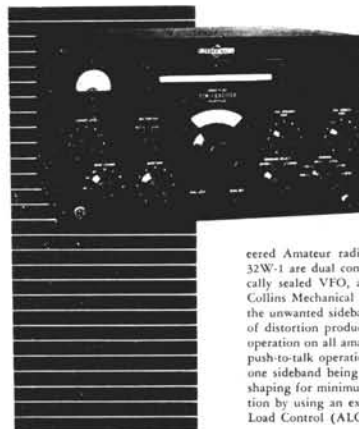

**Figure 3A**  
 Early "30L-1" advertisement that appeared in the 1955 ARRL Handbook.

By late 1954, Collins Radio's marketing strategy had shifted away from advertising the 75A-3 and 32V-3 AM gear to publishing SSB engineering notes in their ad space. It was clear that change was in the making.

Early in the introduction strategy of the KWS-1, the marketing group was calling it the "30L-1" (Ref. 2.), the next logical product model after the AM 30K-1 thru 5 transmitters. There followed an embarrassing product announcement of the "30L-1" (sic) 1 KW SSB transmitter in the 1955 ARRL Handbook, actually layed out in late 1954. See Figure 3A.

About that time, Art Collins decided he wanted the model number of his first KW SSB transmitter/exciter to reflect the kilowatt (KW) and the SSB (S)-model (1) nomenclature.

The KWS-1 was born and introduced to the world in the March 1955 issue of QST (Figure 3B). Actually, afraid that the rather large price would reduce the market acceptance, the introduction included a series of building block products starting with the low end 32W-1 exciter only. This was a KWS-1 exciter without HV power supply and with the low voltage supply in the PA cage area. Figure 4 shows another 32W-1 configuration. The 32W-1, introduced also in March, apparently never went into production.

Note the difference in front panel control configuration between the 32W-1 prototype in Figure 4 and the intro model pictured in the QST advertisement. There was also a power supply location difference. It is evident that the marketing strategy for this version was never clear.



## 75A-4 RECEIVER

The 75A-4 offers passband tuning, AVC for Single Sideband reception, a bridged T rejection notch filter, a crystal calibrator circuit, separate detectors for double or single sideband signals, a new noise limiter circuit that works equally well on SSB, AM or CW, and mounting provision for three separate Mechanical Filters. Retained are the time-proven features of the earlier 75A series — double-conversion, crystal-controlled first injection oscillator for high stability and good image rejection; permeability tuned, sealed master oscillator with accurate dial calibration and long-term stability, and Mechanical Filters in the IF circuits for maximum selectivity.



## 32W-1 EXCITER

Designed to meet the requirements of the most discriminating Amateur whether he operates SSB, AM or CW, the 32W-1 Exciter has sufficient output power to drive a high-level power amplifier stage, and together with the 75A-4 Receiver provides the basic needs for a completely engineered Amateur radio installation. Special features of the 32W-1 are dual conversion, a permeability tuned, hermetically sealed VFO, a Single Sideband generator using the Collins Mechanical Filter to provide optimum rejection of the unwanted sideband, RF feedback to assist in reduction of distortion products, selectable sidebands, bandswitching operation on all amateur bands from 3.5 to 30 mc, VOX or push-to-talk operation, AM operation with full carrier and one sideband being transmitted, CW operation with wave shaping for minimum key clicks and transients, FSK operation by using an external audio FSK oscillator, Automatic Load Control (ALC), and unitized construction.

# Collins PROUDLY ANNOUNCES a NEW STANDARD in AM, CW and SSB OPERATION

It took Collins to produce the first really new Amateur communication system, designed expressly for Single Sideband as well as AM and CW operation. Collins new 75A-4 Receiver/32W-1 Exciter or 75A-4 Receiver/KWS-1 Transmitter combinations are designed for the most exacting Amateur. Engineering-wise, the equipment meets the high standards Collins has set for military and commercial equipment. Price-wise, the Amateur will get more for his money than ever before. See your nearest Collins distributor for your brochure.

## KWS-1 TRANSMITTER

Collins engineering plus extensive on-the-air tests account for the KWS-1 Transmitter's reliability and optimum performance in SSB, AM and CW operation. The exciter and RF power amplifier are housed in a single receiver size cabinet. The Collins 367A-1 linear RF power amplifier uses two 4X150A's in class AB operation. RF feedback is employed to improve the linearity characteristics of the power amplifier. The KWS-1 incorporates circuit application and components which have been proved in preceding Collins equipment; to note a few, the 70E VFO, the Pi-L output network, extremely accurate VFO dial and the Collins Mechanical Filters. To meet the Amateur's future desire for power increase, Collins 32W-1 Exciter can be modified to a KWS-1 at the factory.

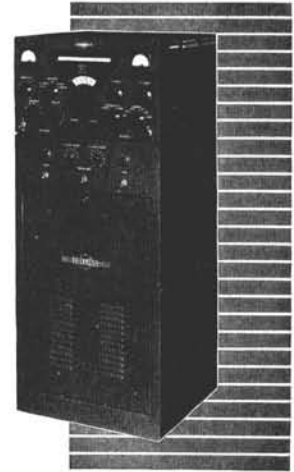

### COLLINS RADIO COMPANY

Cedar Rapids, Iowa  
261 Madison Avenue, NEW YORK 16  
1930 Hi-Line Drive, DALLAS 2  
2700 West Olive Avenue, BURBANK  
Collins Radio Company of Canada Ltd.  
74 Sparks Street, OTTAWA, ONTARIO



**Figure 3B.**

Introduction advertisement for the KWS-1 appearing in the March 1955 QST.

The next block in the line-up, introduced one month later in April, was the KWS-1K which was basically a KWS-1 complete with power pedestal but with the 4X150s (expensive) removed and without the high voltage portion of the power supply. This could be purchased later in either wired form (the 428A-1), or as a kit (the 428A-2) and added by the owner, or the unit could be returned to the factory and converted. Finally if you mortgaged your house, you could buy the entire KWS-1 at one time for \$1,995.00. Thereby, paired with the 75A-4 receiver for \$595.00, earning the lasting nickname of the "Golddust twins".

A few KWS-1Ks were manufactured (the highest serial number observed is #550) and numbered consecutively with the KWS-1. Several people have told me that they believed, like the 32W-1 exciter, no KWS-1Ks were manufactured either. Three units have been seen by the author and one subsequently purchased. These were spread across the country. All were identical with the exception of the serial number and none was being hustled for profit. We believe them not to be fakes.

Ken Roland, still employed by Collins Rockwell and employed there during the KWS-1 days, also believes that some KWS-1Ks were made as they were ordered.



**Figure 4.**

*Collins public relations photo of 32W-1 mock-up or prototype - none were produced. Robert C. Miedke, Engineering Group Head, shown seated.*

This building block marketing strategy was soon deemed unsuccessful and had disappeared from the Collins promotional material by the fall of 1955.

Shortly after the introduction of the KWS-1, Collins was selected by General Curtis LeMay of the Air Force to develop, test and install a complete single-sideband air-to-ground and point-to-point communication system to support the Cold War Strategic Air Command (SAC) Mission.

During the next two years, SAC, Collins Radio and radio amateurs around the world cooperated to demonstrate the effectiveness of SSB global communication.

For this demonstration, standard KWS-1 and 75A-4 amateur equipment was installed in the passenger compartment of both General LeMay's C97 and General Partridges DC-6 aircraft. See this quarterly's cover. These aircraft and subsequently, others were then flown throughout the North Polar region, the Far East, Europe, and Africa communicating reliably with North American test sites.

The KWS-1 went on to serve SAC successfully, leading to the establishment of a Collins Radio equipped, multi-service HF SSB communication network code named Liberty/Rasputin. This

network was eventually equipped with military auto-tune airborne and S-Line base station equipment.

It is believed that ultimately about 1600 KWS-1s (and KWS-1K's) were built with production ending in about mid 1958.

Relatively few variations or design changes occurred during the production run of the KWS-1. This, along with the condition and survival rate of the equipment 35 years later, is testimony to the quality and durability of the initial design.

Early in the design and introduction of the KWS-1, the power pedestal had a louvered front door and a power reset control centered between the filament and high voltage switches. These had disappeared by the time volume floor production commenced. The 6X4 rectifier was eventually changed to a 6AL5 for more stable ALC operation, and other than the original 4X150 PA tubes changing to the more rugged 4CX250B, the only other significant change was the removal of panel adjustable ALC and the replacement of the ALC control with a key lock switch (See Figure 6.). This later change occurred at about serial number 1100. Table I below summarizes significant change and service bulletin timing. Only 6 service bulletins were ever issued. Discussion of some of these is included in the following maintenance text.

At the end of this article is a plot of estimated date of manufacture vs. serial number. This estimate is based on a combination of date code information supplied by owners and serial number data contained in service bulletins and inferred from owners manual revision dates. See Figure 9.

The author solicits more specific information regarding the serial numbers relating to the changes discussed and listed in the table below. Please fill in the requested information on the registration form included with this issue. Note the discussion of serial number registration by name of owner that is also requested in the survey.

(Ref.1.) Report on single sideband techniques and design requirements by W.B. Bruene, May 26, 1964. Collins Research Report.

(Ref. 2.) Collins Collector's Magazine, October 1991, Page 27 note on "30L-1" (sic)

# Table I

Summary of significant changes and service bulletins

| Change     | Description  | Date  | Applies Before | Factory installed after |
|------------|--|-------|----------------|-------------------------|
| Factory    | Removed louvers in front door  | 3-55  |                | 55*                     |
| Factory    | Removed TB504 & changed key & control cable to P104  | ?     |                | 96*                     |
| Ser Bul #1 | Eliminates oscillation on output   | 4-56  | 400*           | 400*                    |
| Ser Bul #2 | K101 arc suppression (crystal MIC use & tube shield change)                                    | 1-57  | 695            | 695                     |
| Ser Bul #3 | Improved K101 arc suppression & ALC/VOX timing   | 6-57  | 1248<br>1083   | 1248<br>1083            |
| Ser Bul #4 | Plate XMFR arcing  | 9-57  | ALL            |                         |
| Ser Bul #5 | L705 10 m tracking with 4CX250B changes & F503/504 SLO-BLO change                              | 11-57 | 1000           | 1000                    |
| Ser Bul #6 | Various includes PA cage insulation removal and P.A. roller coil and capacitor synchronization | 2-59  | ALL            |                         |
| Factory    | 6X4 to 6AL5 ALC  | 11-56 |                | <u>1100-1200*</u>       |
| Factory    | 4X150 to 4CX250B   | 11-56 |                | ""                      |
| Factory    | Fixed ALC-key lock   | 11-56 |                | ""                      |

\* Indicates that serial # shown is approximate.

Along with the changes summarized above, there are a number of service bulletins, or other subjects requiring comment, which will improve the performance or future reliability of your KWS-1. These are presented below and divided by: power pedestal, exciter, and general.

## **Power pedestal related**

### ■ **L501 tuned HV choke**

One of the highest failure rate items in the power supply is the high voltage tuned input filter choke. This results from the proximity of the high voltage within the potted choke winding, to the chokes mounting bolts. This subject was dealt with early on unofficially by Collins - recommending that the owner loosen the bolts and move them to the outer most edge limit of their movement within their mounting hole. This problem still remains and is aggravated by age and the drying out of the potting compound. The Collins recommendation does not eliminate the problem.

#### **Solution**

Remove the mounting bolts one at a time and slip a 6 inch length of 3/16th inch heat shrink tubing over the bolt and replace it. Note: it is not recommended that you mount a failed choke on ceramic stand-offs to eliminate the problem. This is an accident waiting to happen, even if it's to the next unsuspecting owner. If the choke has failed, rewind or replace it (Ref. 3). Clear heat shrink eliminates the potential failure and it is almost undetectable.

### ■ **HV transformer baffle**

Most KWS-1s will have a grey steel baffle plate hanging down from the top left of the plate transformer. Arcing can occur between the winding or the 2.0 KV lead wire and this baffle.

#### **Solution**

Loosen the mounting hardware and move this plate as far from the winding as possible and retighten. Keep the surface of the top and sides of the potted winding as clean as possible. See service bulletin #4. It is recommended that you not remove

this baffle which reduces hum coupling and noise in the cabinet. Point arc sources can be cured using corona dope. See the following discussion about the 2 KV tap leads. I recommend that you do not use silicone. This works, but is very unsightly and difficult to remove later.

### ■ **HV transformer leads (T503)**

Another high voltage failure point is arcing from the 2.0 KV tap leads that come out of the potted high voltage secondary, turn out and attach to the terminal block. These are very close to the edge of the grounded core and with age and stress cracking, failure can occur.

#### **Solution**

Keep the top of the core near the leads very clean. If arcing does occur or if stress cracking is observed, first fill the void in the arced or cracked lead with corona dope - let dry - and then coat the lead, flat core surface along the path, and the corner of the core with another coat. I like to use a preventative coat on the core and winding surface. Corona dope comes in either black or red and is available from your local TV supply house. If you use the black, repairs are undetectable.

### ■ **3B28 high voltage rectifiers**

The older 866 mercury vapor rectifier, while original, is prone to flash-over and has a higher failure rate than the 3B28. This is particularly true if the 866s are old and service has been or will be intermittent. Flash-over can cause failure of T502.

**Solution**—Change to 3B28s

### ■ **HV rectifier filament transformer (T502)**

This transformer is the second highest failure rate component in the power supply - the screen transformer is reputed to be next, however I have never lost one. (Knock on wood.)

(Ref. 3.) Chokes can be rewound by Peter Dahl. See listing at the end of the article.

## Solution

Keep your fingers crossed and use 3B28s. There seems to be no root cause for this except age. External arcing can contribute, however, so do the following. Make sure the transformer primary leads are attached to the bottom of the primary shunt straps and routed away from the high voltage stand-off filament connections that are just above. We've seen several units that were misrouted, probably from changes after they left the factory. It does appear that Collins made their connection to the top of the straps. Move them down.

### ■ Miscellaneous comments

Every time that you work on the high voltage, check the bleeder resistors, blow out the high voltage areas, wipe off the transformer surfaces (alcohol will remove greasy film and not damage the decals and markings), and be careful... Forgive me if this is obvious, but for those not raised on tubes, 275 volts can be a real eye opener and 2 KV can be deadly. When you must work around the active 2 KV, have a buddy present and work with one hand behind your back while wearing tennis shoes.

If any two things will minimize what I like to call high voltage "events", it is cleanliness and a good warm-up period - at least 20 minutes. This helps to drive out moisture, minimizes arcing and sure helps PTO stability, too.

### ■ 120 volt antenna relay power supply

The 100 ohm smoothing resistor comes as a 1/2 watt. This resistor has a very high failure rate and will often be found darkened or cracked. Even though calculation shows the 1/2 watt to be adequate, AC current due to a failed or marginal selenium rectifier, leaking C510, or shorting the relay voltage at the relay cover, leads to short life.

## Solution

Check the selenium for good forward and reverse characteristic or replace for prevention with a 1N4007 silicon diode. Also check C510 and change the 100 ohm resistor to 1 watt.

### ■ Low voltages

Take the time to measure the voltages coming from the power supply. These can be measured or

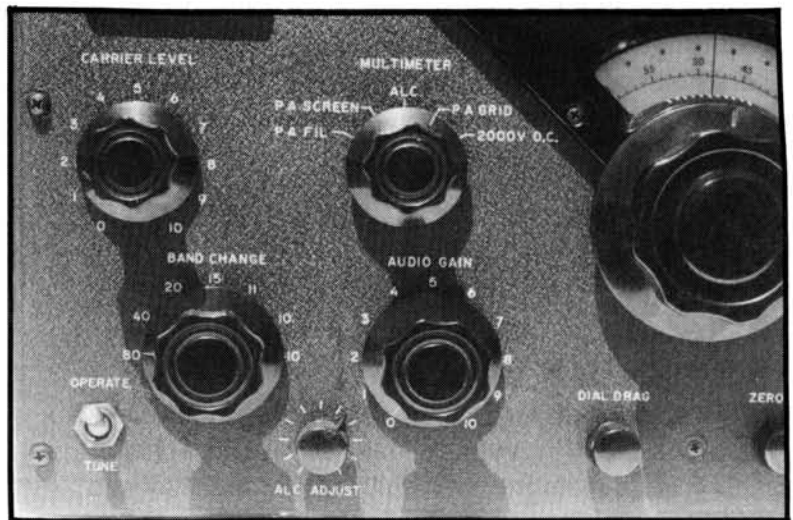

**Figure 6A.**  
Early series exciter with variable ALC control.

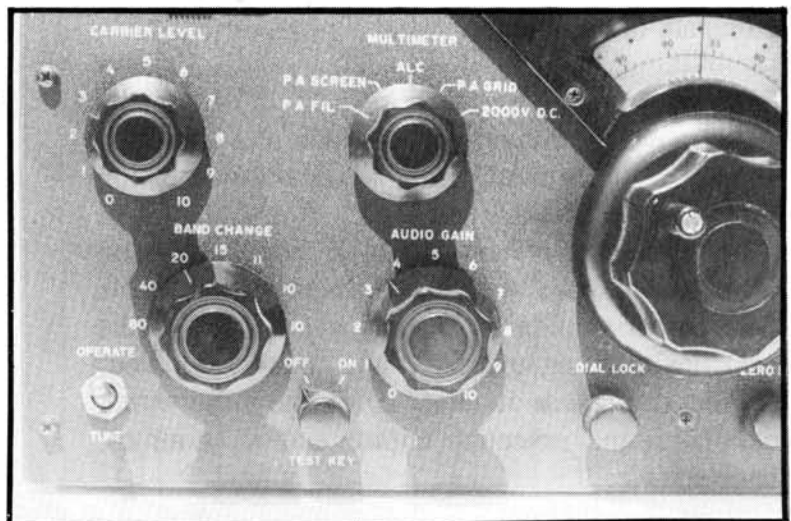

**Figure 6B.**  
Late series exciter with fixed ALC and Test-Key (key lock) switch.

checked easily without removing the back power supply cover as follows:

**Low voltage (275 V.)**

Located at pin 6 of V104 with the tube removed.

**Screen Voltage (350 V.)**

Located at plus terminal stud of multimeter with meter in screen position, tune-operate in operate and high voltage in on position.

**Bias Voltage (-150 V.)**

Check at top of R139 on keying network - see Fig 6-3 of owners manual. Will read minus 30 - 31 volts with emission SW = SSB.

Filament voltage for the final amplifiers should always be set at 6.0 volts + zero/- 0.2 V. This will not reduce emission and will significantly extend the life of the 4CX250B tubes.

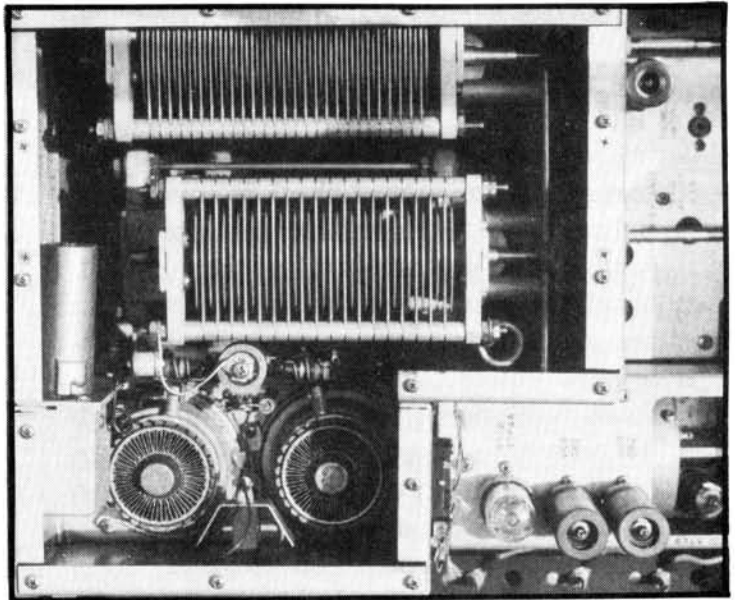
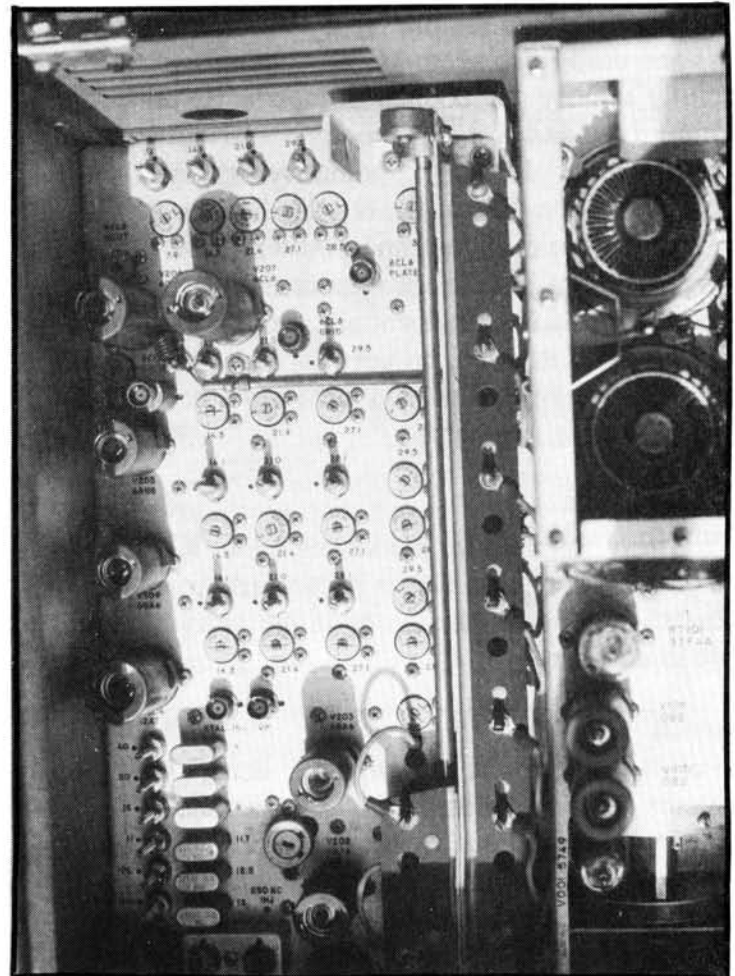

**Figure 7A.**  
*Final amplifier shown with cover off.*

■ **Feeding the KWS-1**

Finally, remember that this equipment was designed when line voltage was 110 volts. Today, 120 volts is more typical and sometimes higher. Jay, KBØATQ, saw more than 140 V the other day while he was operating his KWS-1. At just 125 volts, this is a 14% increase above the design specs for any of the unregulated supply voltages. Any higher can severely damage your unit and a step down transformer or a call to your local power company should be considered. Note that with today's line voltages, the high voltage supply typically runs 2.3 KV unloaded. The high voltage feed-thru capacitor to the RF deck is only rated at 2.5 KV. This is a high failure rate component and is no longer available. A substitute fix is described later.

Finally, the KWS-1 functions much better on 220 volts. Be generous with the wire size.



**Figure 7B.**  
*Exciter/IF stages.*

**Exciter related**

■ **P.A. cage related**

First, be sure that you have complied with service bulletin #6A and removed the insulation that is inside the P.A. cage. This insulation draws moisture and traps dirt.

Also, always check the P.A. tuning and loading alignment of the roller inductors and capacitors to each other and the dial settings. Particularly the loading inductor roller can be bounced off of the coil during rough handling or going against the end stops too hard. The alignment check is covered in service bulletin #6G. With an antenna close to 50 ohms, your P.A. Tune and load settings should closely match the preset chart that is under the lid. A post script on loading: never reduce loading to run at reduced power output. This results in the plate voltage swinging below the screen level and causes the screen to source current. The screen current handling capability of the 4CX250B is easily exceeded. Reduce power out with the carrier control on cw or the audio gain control on sideband. Use minimal to no lubrication inside the RF cage. Most tuning roughness is usually in the turns counters.

**Caution:** The gears on the turns counters are soft brass and easily damaged. If your tuning is rough, carefully remove the counter components, remove all old grease and dirt and lubricate sparingly with a good grade lithium automotive grease and reassemble. Note that the brass gears have probably established a wear pattern and you will have to try several different gear mesh relationships and knob depths on the shaft to find smooth. Do this carefully and it is worth it. Also, be very careful not to lose the little tiny pointer screws. I have never been able to find a source for them.

#### ■ Relays

It is very common for the keying relay, K101, to give contact problems. This is particularly true after extended periods of storage or if the relay clamp diode is not there.

#### Solution

Following periods of storage, or if keying problems are encountered, the contacts should be cleaned with a good quality, non-lubricating contact cleaner on a business card followed with a dry strip of card until the card comes out clean. Blow out any potential paper fibers. The most aggressive cleaning or polishing instrument that you should use is a commercial relay contact "file". You should not be

able to feel the roughness with your fingernail. Harsher, even fine sandpaper, will take off the contact plating and eventually make the problem worse.

The offending set of contacts will probably be the ones keying the antenna relay (inductive load). Unfortunately, these contacts are on the back row and difficult to reach. These contacts can successfully be cleaned by reaching thru the first row of open contacts and closing each individual set of back contacts with a probe. This saves removing the relay. See the following section on the antenna relay keying contact clamp diode.

The antenna relay provided by Collins is external and contains a set of feedback contacts which provide a positive keying bias. The KWS-1 will not operate properly without closure of this feedback line.

These contacts need to be properly timed to close with, but after, the antenna transmit contacts. Properly timed, this protects the transmitter from transmitting full power into an open relay. These contacts are easily damaged and are often found out of time.

#### Solution

Carefully check timing and clean both the feedback and the transmit-receive contacts. Check the security of the relay cover and assure that none of the relay leads can short to ground.

Note: When replacing the screws for the relay cover, do not use screws that are longer than necessary. They will go thru the relay frame and bore a little hole in, and short out the 115 volt coil....Anybody have a bad relay with a good coil??? Some things are best not learned from personal experience.

■ **Antenna relay clamp diode** - Service Bulletin #3 covers addition of a selenium rectifier (little black potted cube -stud mounted) clamp diode located in the rear plug compartment. This diode is electrically across the antenna keying contacts on K101. If this service bulletin has not been done or the selenium rectifier has failed open (common), you will be cleaning K101 a lot.

## Solution

Either perform Service Bulletin #3 using a 1N4007 and a 2 lug ungrounded small terminal strip mounted in the available hole, or if the selenium is there and failed open, just mount the 1N4007 across the terminals of the failed diode. The arc suppression network installed per SB #2 may be left in place.

### ■ Switches

While you are cleaning relay contacts, or if the unit has been in storage, clean all the switch contacts with a non-lubricating switch contact cleaner. You can then go back and very carefully put a small amount of contact lubricant on just the contact itself. Avoid getting lubricant on the switch frames. At the same time, put a small amount of white lithium grease on the ball/detent area of the switch.

**Caution:** A word of warning about the emission switch. With normal assembly tolerances, the back contacts of the switch can come very close to the internal front face of the main chassis. Improper assembly of the switch to the front panel - extra or thick washer -or getting the side panels full back against their tolerances can result in electrical shorts or roughness and damage to the wiper or contacts. Any sign of switch grabbing or erratic electrical operation during switching is grounds for investigation. Many of these switches have been found damaged.

**Another caution here:** During front panel disassembly, be careful to polish any set screw burrs off the PTO shaft prior to pulling the shaft back thru the panel bearing. Failing to do this will result in a rough running PTO or a sloppy one if you have to go in and polish out the shaft bearing.

### ■ Alignment

Alignment is straight forward with but a few exceptions. The KWS-1 manual is quite good and should be followed as required with one very important exception. This will be covered, along with some other comments.

First, don't attempt alignment without the correct equipment. In addition to what is listed in the manual, you should also have either a scope or a

spectrum analyzer. You should also have a clear understanding of the frequency conversion scheme, the units function and intermediate frequency bandswitching.

Be sure whether you are adjusting a peaked circuit or a trap. I have found several KWS-1s with peaked traps.

I have included a top view location diagram, see Figure 8, for the tuning inductors called out in the alignment procedure. This will save a lot of hunting around. I suggest making a copy and putting it with your manual. Also, included is a table of typical AC (both audio and RF) signal levels encountered throughout a good unit.

See Table II. These values have been derived from measurements on five different units and should be fairly representative.

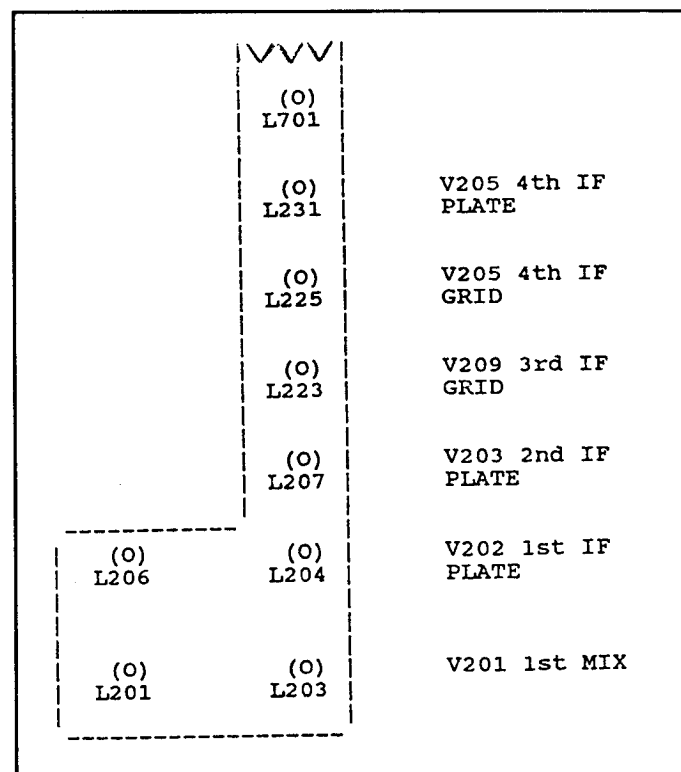

**Figure 8.**  
Top view of slug rack tuning inductors labeled by function.

Be careful when putting test cables on the available BNC test points. Almost all these nodes are high impedance. Running a length of 50 ohm cable to a high impedance scope or microvolt meter, for instance, will load down the node and invalidate the measurements.

## TABLE II

Typical AC signal levels in properly functioning KWS-1  
(Measurements taken @ 14.25 MHz  $f_{PTO}$  and conditions shown)

| Test Point  | Indication  | Conditions   |
|---|---|--|
| 250 KHz INJ.                                      | 85 mV @ 3.0 MHz feedthru with<br>< 50 mV 60 Hz<br><br>300 mV & 250 KHz<br><br>1.0 Vpp @ 250 KHz   | Emiss = SSB<br>HV Off<br>XMIT not keyed<br><br>Emiss = CAL<br>HV off<br><br>Emiss = SSB<br>HV on, XMIT keyed, full 2 KHz mod to<br>500 mA final plate current  |
| VFO INJ.  | 6.8 Vpp @ 3.0 MHz<br>Slight distortion normal   | Independent of emission & XMIT status  |
| XTAL INJ.   | 4.6 Vpp @ 11 MHz  | Independent of emission & XMIT status  |
| VIF   | 2.0 V at 3.0 MHz feedthru from<br>PTO<br><br>< 100 mV of modulation--hum and<br>noise<br><br>1.25 Vpp (modulated) @ first IF<br>frequency | Emission = CAL<br>(HV Off)<br><br>Emission = SSB<br>HV on<br>XMIT keyed<br>No modulation - open MIC<br><br>Emission = SSB<br>HV on, XMIT keyed<br>Full modulation @ 2 KHz to 500 MA<br>final plate current - ALC set |
| 6CL6 CATH   | 18 Vpp @ 14.25 MHz  | Same as above  |
| 6CL6 PLATE  | 22 Vpp @14.25 MHz<br><br>52 Vpp @ 14.25 MHz   | Same as above<br><br>Emission = CAL<br>No modulation   |
| AUDIO<br>P6 V101<br>P2 V101<br>P1 V101<br>P3 V102 | 7.9 Vpp @ 2KHz<br><br>16 mV @ 2 KHz<br><br>440 mV @ 2 KHz<br><br>480 mV @ 2 KHz   | MIC gain @ 4 (11:00)<br>Emission = SSB<br>HV on, XMIT keyed<br>Modulation to full 500 mA output<br>ALC set & driven to midscale  |

**Caution:** There is one strong caution that must be heeded. On almost 50% of the KWS-1s that I've aligned, the manual procedure will result in a oscillating or marginally stable 2nd IF stage (V203). This will result in, at the best, spurious emissions and at worse, full output with no modulation on SSB. This will appear on a frequency very close to the units true "transmit frequency".

### **Solution**

When aligning L207 and the corresponding 3.1 MHz trimmer, monitor the IF waveform at the 6CL6 driver plate with a scope or spectrum analyzer. If any sign of instability (a beat frequency on a scope or spurs on the spectrum analyzer) is present, de-tune L207 until the instability disappears. After tuning (or de-tuning), the stability should be checked CW and under modulation across the full frequency range of the PTO, not just the alignment points. As a final check of stability, remove the PTO oscillator tube and monitoring both the scope and final grid current, there should be no output across the full PTO/slug rack tuning range. Ample drive will still exist after any required de-tuning.

### ■ **Bad aligning problems**

For a unit where aligning tinkering is suspected - it is very easy to accidentally get the first IF tuned to the PTO frequency - a good way to start your alignment is by pulling both the PTO (V001) and the 250 KHz oscillator (V104) tubes thus disabling these oscillators.

Still setting the dead PTO at the correct 80m alignment points - this positions the slug rack correctly - inject 100 mV<sub>p,p</sub> at the 80m alignment frequency into the 250 KHz injection test point. Use a good signal generator with a frequency counter and follow the aligning procedure in the manual. This requires a bit of juggling of generator frequency and slug rack position but will quickly sort out any alignment questions in the first IF.

### ■ **Grounds**

It is a good idea, while you are in for alignment, or if IF oscillation or other grounding problems are suspected, to move and retighten all suspected ground lugs. Collins used silver plated ground lugs and many are positioned against the steel irradiated

chassis or tube sockets. Over the years contact resistance has gone up. Simply moving and retightening these will correct most of the problem. This problem is also found in the S-line series.

## **General**

### ■ **Molded paper capacitors**

Many of the problems encountered in the audio sections (modulation thru to balanced mixer and Vox/Anti-vox) or ALC function can be traced to leaky paper molded capacitors. These caps are typically black molded tubulars with color code bands. Several of the higher value caps are light green with color codes.

In any one rig, if more than one or two capacitors are found bad, all should be checked and probably changed. There are not that many and their failure rate is high.

While looking in-circuit for bad capacitors, leakage can be inferred by looking at the associated DC voltages in the voltage table (Table 5-4) shown in your instruction manual. Measured voltages should agree very closely with the table.

Table III below shows some of the highest failure rate capacitors, their location and the normal symptoms produced by the failure.

When replacing these caps, use high quality polystyrene caps of equal or higher voltage rating. Careful voltage and signal tracing, and the subsequent capacitor replacement will reward you with hum free clean modulation and reliable Vox/Antivox and ALC operation.

Again, most complaints of difficult VOX operation - including erratic manual PTT - can be traced to leaky caps or AC hum being fed into the antivox circuit from the receiver.

### ■ **C416 replacement**

If C416, the 2.5 KV rated .01 mfd feed-thru fails, a replacement must be fabricated. Rudy Kerl, K2MVW, has done a very nice job by covering the existing hole with a 1 3/8" by 2 1/8" piece of .250" Teflon drilled to mount in the existing C416 flange holes and having a 10-32 stud run down the center from close to J402 to the bus wire from L403 (existing). A .01 mfd 4KV disk is then mounted

# TABLE III

Leaking capacitor symptom table -  
Common failure locations

| Symptom   | Capacitor   | Function   |
|---|---|--|
| VOX will not set properly.<br>Mike PTT switch may not pull<br>in K101 | AC Hum on anitvox line  | -----  |
| VOX touchy to set up and<br>K101 hangs up                             | C113<br><br>or<br><br>hum on MIC line C104A/B<br>or ground loop | Leaky VOX amp to VOX rectifier<br>coupling<br><br>MIC amp AC filtering       |
| Distorted or weak audio-MIC<br>input to balanced modulator            | C103, C105, C132, C106<br>(Particularly C106)                   | Audio coupling   |
| Improper keying (BIAS)  | C127, C134  | CW shaping and phone cutoff bias   |
| Erratic (very sensitive) or bad<br>ALC                                | C413 with 6X4<br><br>C403,C413, with 6AL5                       | ALC time constant<br><br>(NOTE: In later KWS-1s check<br>also C325 and C324) |
| P.A. screen 350 V. supply<br>cannot be adjusted to spec with<br>R511  | C506<br><br>Replace with <u>600 V.</u><br>.022 mfd              | Regulator<br>Loop Stability  |
| Shorted high voltage at J402<br>feedthru<br>Blown HV fuse             | C416<br>NOTE: See text for<br>replacement                       | High Voltage 2.3 kV to P.A. cage   |

inside the cage from the stud to a ground lug on one of the Teflon plate mount screws. This problem was also creatively solved by Jack Kennedy, W5DJ, by using a ceramic insulator feed-thru and running the disk bypass the same as Rudy did. Both work well.

Finally the following are suggested as reliable parts sources:

#### TUBES & CAPACITORS

Antique Electronic Supply  
6221 S. Maple Avenue  
Tempe, Arizona 85283  
(602)820-5411

#### METER RELATED

Bartlet Instrument Company  
P.O. Box 445  
Ft. Madison, Iowa  
(319)372-8366

#### TRANSFORMERS - REPLACE/REBUILD

Peter Dahl Company  
5869 Waycross Avenue  
El Paso, Texas 79924  
(915)751-2300 FAX 751-0768

#### FAN BEARINGS

Bill Carns, N7OTQ  
9708 East Desert Cove  
Scottsdale, AZ 85260  
(602)391-1158

or

Microminature Bearing Company  
7 Jocama Boulevard  
Old Bridge, New Jersey 08857  
1-800-526-2356  
(BEARING PART #70882-Z)

#### MISCELLANEOUS PARTS

##### NEW PARTS:

Dennis Brothers, WAØCBK  
HC84, BOX 1  
Potter, Nebraska 69156  
(308)879-4552

Nebraska Surplus  
1502 Jones Street  
Omaha, Nebraska  
(402)346-4750

##### USED PARTS:

Ron Follmar, K5GIT  
1409 W. Willis  
Alvin, Texas 77511  
(713)331-1074

#### PAINT - CONTACT AUTHOR OR:

Bill Wheeler KØDEW  
272 Donna Lee  
Lebanon, Missouri 65536  
(417)532-7710

#### MANUAL/SERVICE BULLETINS

Vista Technology, Inc.  
3041 Rising Springs Court  
Bellbrook, Ohio 45305  
(513)426-6700

#### REPAIR

Howard Mills, W3HM  
Route #3, Box 712  
Harper Ferry, West Virginia 25425  
(304)876-6483

Mike Palmer, K5FZ  
16707 Creeksouth  
Houston, Texas 77068  
(713)444-7737

NOTE: Dennis Brothers does repairs, but currently has more than a one year backlog. See listing under PARTS.

#### HIGH VOLTAGE FUSES (HVB-1)

Who has a continuing source? Please contact the author.

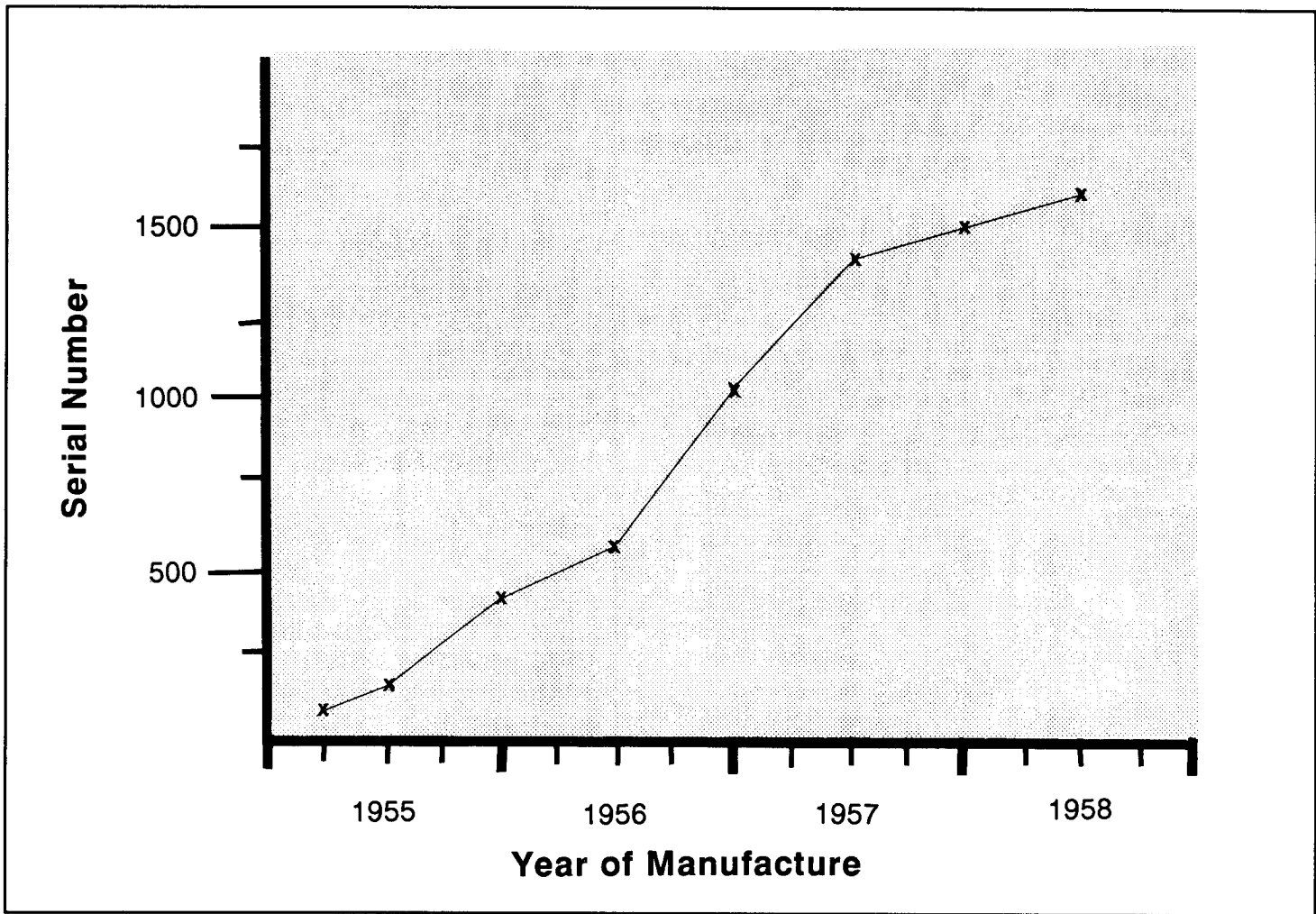

**Figure 9.**  
*Estimated KWS-1 serial number vs. manufactured date.*

In closing, I hope this helps as you work on, and enjoy, your KWS-1s. I look forward to hearing from you via the survey or otherwise.

de N7OTQ

# A Look Back

Introduction of the Collins KWS-1 in advertisements that appeared during the 1950s.

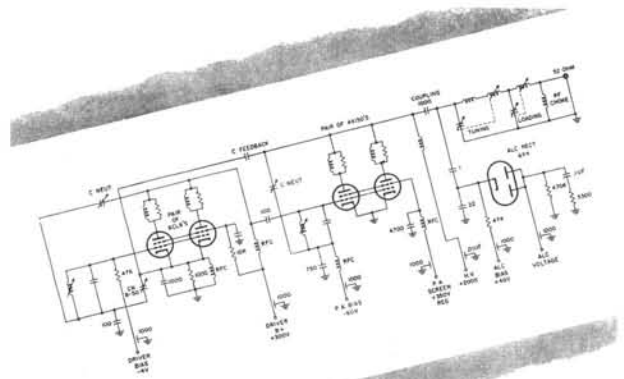

**DISTORTION FREE**

# SSB

at its finest *Collins* **KWS-1**

Reduced bandwidth requirements—one of the foremost advantages of SSB is effectively utilized by the linear operation and low distortion of the KWS-1. Class AB<sub>1</sub> Operation of the PA, RF feedback from PA to driver stages and bridge neutralizing circuits in both the power amplifier and driver stages provide a high degree of linearity. Additionally, an automatic load control circuit limits excitation peaks allowing a higher modulating level to give the effect of audio compression without introducing undesired distortion. Overall, the distortion products are down more than 35 db. These are but a few of the design features incorporated in the KWS-1 to insure the improved performance of single sideband transmission.

See your nearest Collins distributor



## exclusive in the Amateur Field...



### *Collins* KWS-1 TRANSMITTER

the finest kilowatt in Amateur SSB history owes its fast-growing reputation to features such as these—exclusive with Collins:

- **ADVANCED SAFETY MEASURES** include complete interlocking of the high voltage circuits, no exposed high voltage in RF cabinet, and p.a. plate meter in B-lead.
- **1 KC DIAL DIVISION** on all bands — 80 through 10 meters.
- **SPECIAL SIDEBAND GENERATION** utilizing Mechanical Filters provides 60 db sideband suppression.
- **PERMEABILITY TUNED CIRCUITS** allow effective spurious suppression.
- **DUAL CONVERSION**, with stability comparable to the famous 75A Receivers, makes the KWS-1 as stable on 10 meters as it is on 80.
- **UNPRECEDENTED COMPACTNESS** with all controls necessary for tuning and operating in one receiver-size cabinet.
- **NO P.A. BANDSWITCH**. Network for continuous tuning from 3.5 to 30 mc with constant L/C ratio over entire range.

Write or visit your nearest Collins distributor for complete information on Collins new SSB Amateur line, and ask for your copy of this latest brochure.

COLLINS RADIO COMPANY, Cedar Rapids, Iowa



## NOW... Optional Equipment Combinations for COLLINS KWS-1 AMATEUR TRANSMITTER

Collins KWS-1 incorporates the most advanced design features ever offered in an Amateur transmitter — new compactness, new ease of operation, and optimum performance on SSB, AM and CW.



KWS-1 Transmitter

This new Collins transmitter will soon be available as a complete ready-to-operate kilowatt or as individual sub-units as listed below.



KWS-1K



32W-1

- **KWS-1** Transmitter complete \$1,995.00
- **KWS-1K** Transmitter similar to KWS-1, less high-voltage power supply and PA tubes..... 1,225.00
- **32W-1** Exciter and low-voltage power supply. Also includes one socket for two 4X150A tubes in shield box to be used if 32W-1 is later converted to a KWS-1..... 895.00
- **367A-2** Power Amplifier Kit includes all components, except two 4X150A tubes, to convert the 32W-1 to a KWS-1..... 215.00
- **428A-1** High-voltage power supply for KWS-1, completely assembled and wired..... 700.00
- **428A-2** High-voltage power supply similar to 428A-1, except supplied in kit form..... 545.00

See your nearest Collins Distributor for additional information.

COLLINS RADIO COMPANY • Cedar Rapids, Iowa



**Forerunner of Tomorrow... here today!**

In its entire Amateur line, Collins has long been recognized for its leadership in forward-thinking design and development. Now leading the trend to Single Sideband excellence, Collins is producing the top performing team on the air — the KWS-1 Kilowatt Transmitter and the 75A-4 Receiver.

You can be enjoying this forerunner of tomorrow — today — on a small down payment and up to 18 monthly installments. Your nearest Collins distributor will be happy to give you the figures today.

**Collins** CREATIVE LEADER  
IN COMMUNICATION

**A NEW EXPERIENCE AWAITS YOU IN SSB**

**Collins** CREATIVE LEADER IN COMMUNICATION



**Collins for NEW EASE in OPERATION**

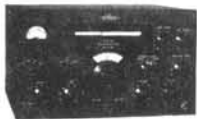

The new Collins 75A-4 Receiver, 32W-1 Exciter, and the KWS-1 Kilowatt Transmitter are expressly designed for SSB, AM and CW. Like all Collins Amateur equipment, they meet the same high standards as Military and Commercial equipment.

The 75A-4 Receiver features passband tuning, AVC on SSB, bridged T rejection notch filter, built-in crystal calibrator circuit, separate detectors for AM and SSB, a new noise limiter, and provision for three Mechanical Filters together with time-proven features such as good image rejection, and an accurate linear dial with calibration of 1 kc per division.

Transmitter features include a SSB generator using Collins Mechanical Filters, selectable sideband, band switching from 3.3 to 30 mc, voice control or push-to-talk, automatic load control, and diad conversion with crystal controlled high-frequency oscillator and stable, linear, permeability-tuned low frequency oscillator resulting in a linear dial similar to the 75A-4 Receiver.

Power input is one kw peak envelope power on SSB, one kw on CW, and equivalent to one kw AM when received on narrow-bandwidth receiver.

Several versions of the transmitting equipment are available. The 32W-1 Exciter is capable of driving a kw linear amplifier. With exception of the power supply, which is housed in a separate cabinet, it is complete in a receiver-type cabinet and can be converted into a KWS-1. The KWS-1 is also complete in a receiver-type cabinet except for power supplies, which are mounted in an attractive sleek-high cabinet. As an alternate, the KWS-1 is available without the high voltage power supply as type number KWS-1K, and kits are available for converting a 32W-1 or a KWS-1K into a KWS-1.

AMATEUR NET PRICES ARE AS FOLLOWS:

|  |            |
|--|------------|
| 32W-1 Exciter complete                                   | \$ 895.00  |
| KWS-1 Transmitter complete                               | \$1,995.00 |
| KWS-1K Transmitter less H.V. power supply and P.A. tubes | \$1,235.00 |
| 428A-2 H.V. Power supply kit for KWS-1K                  | \$ 545.00  |
| 428A-1 Power supply for KWS-1K, wired and tested         | \$ 700.00  |
| 367A-2 P.A. Kit to convert 32W-1 to KWS-1K               | \$ 215.00  |

See your nearest Collins distributor for delivery information.



**Why this rig is a sound Financial Investment**

The advanced design and careful craftsmanship in Collins SSB equipment naturally results in a high lasting value on the market. After years of top performance, an important part of the purchase price will be returned to you as trade-in value. You'll be surprised at the low cost per day.

A Collins SSB rig is a sound financial investment. You can now purchase this superior equipment on a convenient Time Payment Plan and operate while you pay. See your distributor for complete details.

**Collins** CREATIVE LEADER IN COMMUNICATION

ANOTHER REASON for  
Top Amateur Performance

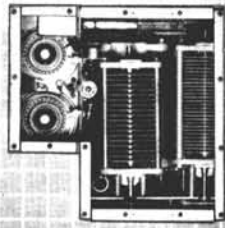

## Collins KWS-1 SSB LINEAR



75A-4



KWS-1

The reputation for superior performance in the 75A-4 Receiver and KWS-1 Transmitter is no accident. Many problems were met and solved to give you this top Amateur team.

For example: Collins engineers wanted to design a *table-top* kilowatt SSB transmitter. In order to do this, they first had to design a superior linear amplifier in a small package. The result is the Collins KWS-1 linear — efficient, compact, with exceptionally low distortion.

### FEATURES

- Inverse  $\pi$  feedback used to improve distortion generated in the PA and driver. Third order distortion products better than 35 db down.
- ALC (Automatic Load Control), a circuit similar to AVC in a receiver, prevents modulation peaks from driving the PA into distortion. This permits a high average percentage modulation.
- Bridge neutralizing circuit used to eliminate regeneration and instability.
- Two 4X250B tetrodes used in Class AB1 operation for optimum linearity and low drive requirements.
- Combination Pi-L output network results in excellent harmonic attenuation. This network is continuously tuned and requires no handswitching.

For complete information and specifications plus price data, contact your nearest Collins distributor.

COLLINS RADIO COMPANY, Cedar Rapids, Iowa



COLLINS NEW

# Time Payment Plan

MAKES THE FINEST SSB EQUIPMENT  
AVAILABLE NOW



Collins 75A-4 Receiver, 312A-1 Speaker Control, KWS-1 Transmitter and Power Supply.

Collins Radio Company and its distributors have made it possible for you to operate the new Collins SSB rig while you're paying for it. It can be yours right now by taking advantage of the new Collins Time Payment Plan. A small down payment will team you and superior SSB performance on the Ham bands. Your present equipment may apply on the down payment, too. See your Collins distributor — he'll explain how that Collins rig can be yours for a few dollars a month, with up to 18 months to pay.

### Here's how easy it is to own Collins SSB equipment

Take the Collins 75A-4 Receiver for example. For as little as \$59.50 down, you take your 75A-4 home and start operating. You can choose the plan that fits your budget best — as low as \$33.00 a month for 18 months, or fewer payments if you wish.

Here's another good point to consider: Collins advanced engineering and quality construction give you a station with lasting value. When it comes time to modernize your rig in the years ahead, your Collins equipment will retain its position of top trade-in value on the Amateur market.

Collins CREATIVE LEADER IN COMMUNICATION



ANOTHER REASON for  
Top Amateur Performance



## Collins PRECISION VFO



Another reason for the superior performance of Collins KWS-1 Transmitter and 75A-4 Receiver is the use of Collins Variable Frequency Oscillator — famous for its linear calibration and stable output. The units in the KWS-1 and 75A-4 are designed specifically for Amateur operations and are 100% tested under lab conditions to rigid specifications.

**ACCURACY** — With Collins VFO, you accurately set dial calibration to 1 dial division (1 kc) on any band. And with the 75A-4 crystal calibrator, it gives even greater accuracy and accurate band-edge operation.

### STABILITY

- An average of 24-hour stability of .003% or better is achieved under normal operating conditions.
- Precision ball-bearing construction allows single-knob, permeability tuning with rock-steady vibration stability.
- Each unit is hermetically sealed against atmospheric changes for life-long, drift-free operation.
- Each unit is individually temperature-compensated for minimum drift. Each is lubricated for life.

For more detailed information on Collins KWS-1 and 75A-4 visit or write the Collins distributor nearest you.

COLLINS RADIO COMPANY, Cedar Rapids, Iowa



Step into  
this picture  
it's easier than you think

This could easily be a picture of your rig, and — just as easily — you could be enjoying the top performance in Amateur history now.

Collins Time Payment Plan makes it both easy and smart to work the finest SSB while taking up to 18 months to pay small monthly installments. With Collins consistently top trade-in value, your cost per day is also surprisingly low, making this a sound investment.

Ask your Collins distributor for the figures today.

Collins CREATIVE LEADER  
IN COMMUNICATION

